

ROBAM

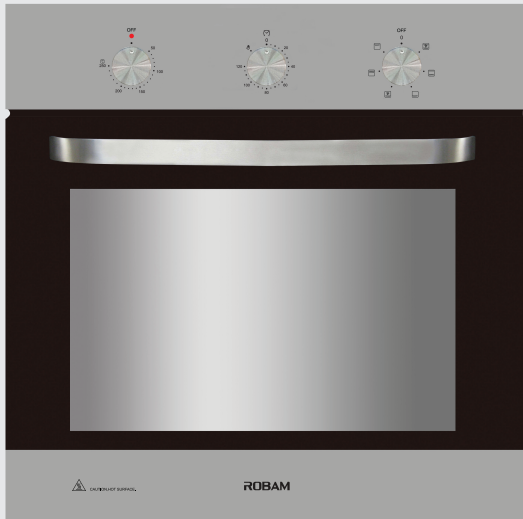

使用说明书 User Manual

使用产品前请仔细阅读本使用说明书，并妥善保管。如果说明书丢失，您可以发送邮件至 overseas@robam.com，获取电子版说明书。

Before operating this unit, please read the user manual completely and keep it. If the manual is lost, you can send e-mail to overseas@robam.com, request for an electronic manual.

KQWS-2350-R315S

电烤箱

Electric Oven

Cod:0040306776



目 录

安全注意事项.....	1
产品简介.....	3
安装说明.....	4
使用说明.....	5
常见故障及处理方法.....	10
维护和保养	10
电气原理图	12

安全注意事项

为了避免给使用者及其他人员造成危害或者财产损失，特作如下区分及标志。
均为有关安全的重要事项，敬请严格遵守，并在充分理解内容的基础上正确使用。







根据危害、损害程度进行的内容区分

 危险	若忽视这一标志，并进行错误操作，极有可能导致人员危险、重伤或引起火灾。
 警告	若忽视这一标志，并进行错误操作，有可能导致人员危险、重伤或引起火灾。
 注意	若忽视这一标志，并进行错误操作，有可能导致人员受伤或造成物品的损害。

注意、禁止内容的图标

 禁止	 禁止明火	 禁止触摸	 禁止拆卸	 严格执行	 需要接地	 当心触电	 小心烫伤
--	--	--	--	--	---	--	--

 **警告** 请严格按照本说明书规定使用，由于本产品使用不当造成的任何财产损失、人身损害，本公司不承担责任。





 危险	
 严格执行 拔出插座上的插头时，必须手握插头的端部将其拔出，请不要手拿电源线拔插头，否则易发生触电、短路、起火等危险。	 禁止 请不要使用松动或接触不良的电源插座，否则易导致触电、短路、起火等危险。
 严格执行 为避免可能出现的电击，换灯泡前应确定器具已断开电源。	 严格执行 整机远离热源，煤气和酒精等易燃物品。
 小心烫伤 器具在使用期间会发热，注意避免接触电烤箱内的发热单元，以免烫伤和灼伤；工作结束后取出食物时务必戴好耐高温保护手套，以免烫伤。	

ROBAM老板 | 电烤箱

警告

 严格执行 如果电源软线损坏，为避免危险，必须由我公司或我公司维修部或类似的专职人员来更换。	 需要接地 单独使用16A或以上的插座，请勿与几个电器同时使用同一个电源插座，并确保插座安全有效接地。
 严格执行 若器具出现故障请立即断开电源停止使用，并且不要触摸器具，请专业人员维修。	 严格执行 不得损伤电源线。使用电源线时不得弯曲、拉伸、扭转、打结。不得用重物扣压、夹击电源线。
 严格执行 为防止火警，器具必须保持清洁，风道必须畅通无阻。	 严格执行 移开风扇保护装置前必须将电烤箱断电。清洁后，必须按使用说明把
 严格执行 用好后立即关闭器具，否则残余的脂肪会引发火警；器具长期不使用，应切断电源。	 严格执行 工作结束后，打开器具门时会有热气喷出，不要离器具太近，以免热气烫伤。
 严格执行 器具在使用期间可触及部分可能会发热，儿童应远离。	 禁止 禁止无人照看的幼儿和残疾人使用此器具，并禁止儿童玩耍器具。
 禁止 不要使用粗糙洗涤剂或锋利的金属刮刀清洁烤箱门的玻璃，如果烤箱门的玻璃表面被擦伤，这样做会导致玻璃粉碎。	 禁止 不可将易燃物质（例如烟雾剂）放置在器具的里面和下面；使用器具时，不得在其附近喷洒烟雾剂，必须始终有人看管。
 严格执行 清洗时必须切断电源，注意使用中 性清洗剂。同时使用柔软抹布擦洗，防止划伤表面。	 严格执行 请勿在手脚潮湿或赤脚的状态下操作器具。

注意

 严格执行 若器具出现功能不正常时，请拔掉电源插头重新上电。	 严格执行 使用时内部烤架、烤盘等放置必须正确到位。
 禁止 不能使用蒸汽清洁器。	 禁止 器具不能用作室内取暖器。
 严格执行 使用该烤箱推荐的温度传感器。	

产品简介

亲爱的用户：

让我们借此机会，对于您购买了老板牌电烤箱系列产品表示衷心的感谢。我们特别建议您在着手安装和使用本产品前，有必要仔细阅读此说明书，并请将其妥善保存，以备今后查阅。

本公司是国内生产吸油烟机、电烤箱、燃气灶具、消毒柜等家用电器和厨具的专业企业。老板牌电烤箱采用先进的设计理念，优化造型，注重整体设计与橱柜搭配；本产品经国家各级检测机构测评合格；使用独有的电码防伪标志，保证用户购买正牌产品，维护自身利益。

重要信息

电烤箱的包装

请以环保的态度处置这些包装材料，以保持一个良好的环境。

请勿让儿童玩耍塑料薄膜、纸箱等包装材料，这可能会产生窒息事故，所以请让包装材料远离儿童。

产品特点

- 本烤箱是通过电加热管通电变热，使腔体内的空气加热升温，继而对腔体内的食物进行烘烤至熟。此过程是通过热传递的方式对食物由外而内加热，这种加热方式不会破坏食物原有的美味，更可保留食物中所含有的水分和营养成分。烹制食物外酥内嫩，适合东方人的口味。
- 内膛及烤盘采用搪瓷处理，工作过程中不产生有害物质。

产品技术参数

型 号	KQWS-2350-R315S
额定电压	220-240V~
额定频率	50-60Hz
额定功率	2350W
容 积	59L
净 重	27kg
外形尺寸 宽×高×深(mm)	595×595×531

安装说明

在橱柜的设定位置上，按下面安装图示设定方孔，将电烤箱平稳嵌入该方孔，注意不得倾斜安置，具体开孔尺寸(mm)见下表：

序号	名称	A	B	C
1	全嵌开孔尺寸(宽×高×深)	600	600	560
2	半嵌开孔尺寸(宽×高×深)	564	600	560

(图片仅供参考，以实物为准)

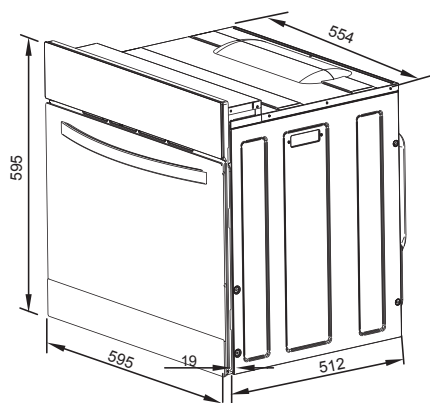

整机尺寸示意图

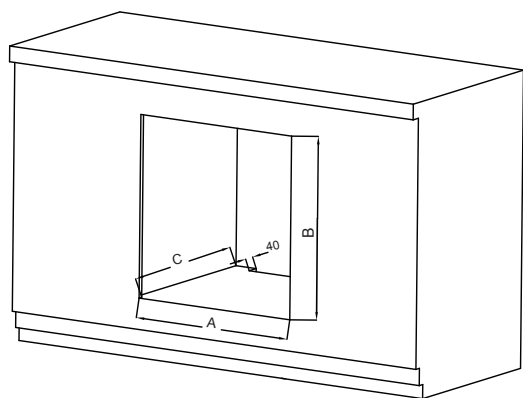

全嵌开孔示意图

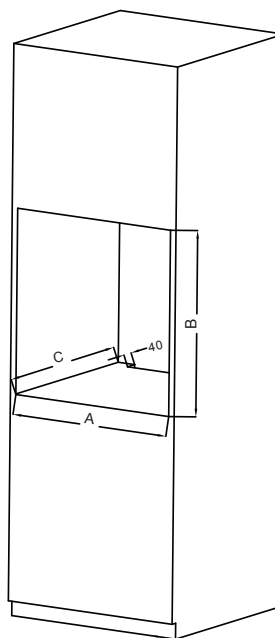

半嵌开孔示意图

安装要求：

- 安装电烤箱平面必须平整，柜内尽量使电烤箱周围空气流通，建议夹板和固定板采用不可燃绝热材料。
- 电源线接插方便，单独使用**16A**或以上的插座，请勿与几个电器同时使用同一个电源插座，并确保插座安全有效接地。周边若有其他电器，请确保安装距离大于**100mm**。

使用说明

控制面板介绍

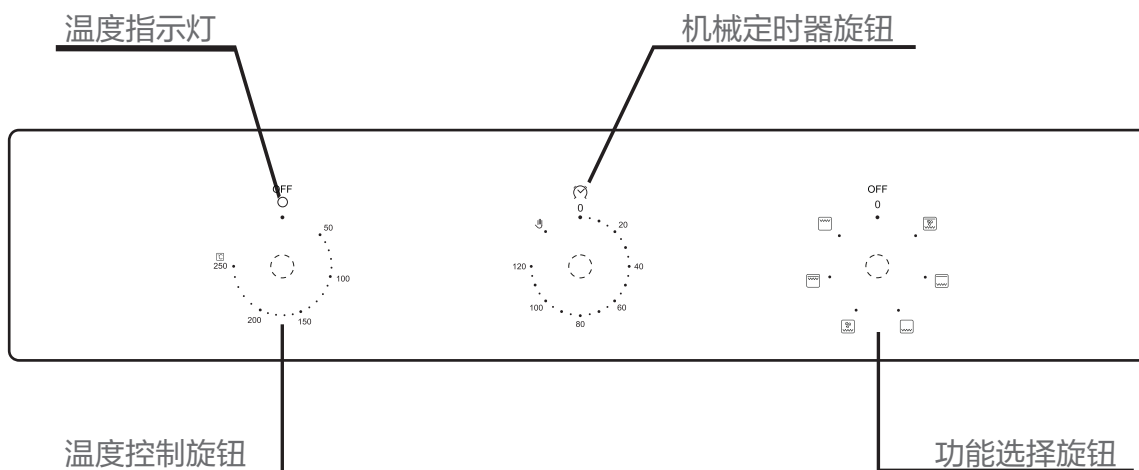

使用前说明

- 首次使用烤箱时都会有异味发出，是由于储存期间电烤箱加热元件有涂层保护，加热后涂层蒸发所致，所以先使房间保持通风，选择风扇烤功能，设定最高温度及最长工作时间，在没有食物的情况下进行加热蒸发涂层异味，工作结束后打开烤箱门冷却，确保后续烘烤的美味度。
- 关机后如产品内部元件温度过高，风机会延迟一段时间后停止运转，有利于延长机器寿命。
 温馨提示：电烤箱在使用时，建议您打开吸油烟机。

使用方法

- **选择功能：**
 旋转功能选择旋钮到所需功能对应的位置，此机型为6功能烤箱。
- **选择烘烤温度：**
 烤箱功能设定完毕后，顺时针旋转温度控制旋钮到所需的温度。设定完毕后，红色指示灯亮起。

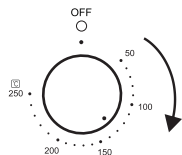

- **选择烘烤时间：**

顺时针旋转定时器旋钮至需要烤箱工作的时间。时间设置范围为：0-120分钟。下图为定时器处于不同位置时的功能。

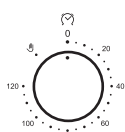

零位

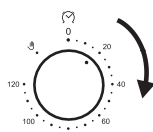

设置定时

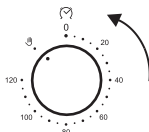

不设置定时，烤箱持续工作

ROBAM老板 | 电烤箱

● 照明灯功能

将功能选择开关旋转到任一功能，温度、定时器均不设置，此时仅照明灯工作。旋钮的位置如下图。

注：在正常烘烤过程中，照明灯将一直亮。

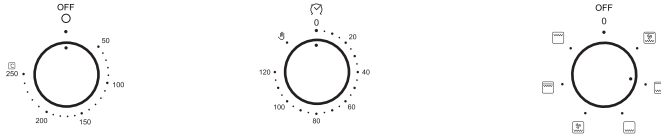

● 腔体冷却功能

将功能选择开关旋转到任一带对流风扇的功能，温度、定时器均不设置，此时仅照明灯与对流风机工作，可实现腔体冷却。旋钮的位置如下图。

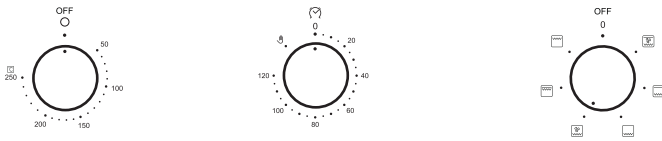



















- 由于制造过程中残留的油脂以及其他保护物质的存在，烤箱初次使用时，可能会有异味，请选择 功能，设定温度250℃持续工作1h，然后打开烤箱门通风使异味溢出。
- 本指南列举了食物烹饪的温度范围和大致时间，也可以通过调节来满足您的个人爱好。
- 为了获得最佳效果，请先将烤箱预热，待温度指示灯灭（全机械控制烤箱）或设定闹钟倒计时完成，蜂鸣器响起表示预热完成后，再将食物放入。
- 使用带有风扇的功能时，建议将温度设置调低约10℃-20℃，或将时间减少约10分钟。具体的烹饪效果请根据个人喜好调整。
- 食用前请确保食物已经充分烹调。
- 表格中的数值仅供参考，具体请根据您的经验和喜好进行调整。
- 部分菜品以及功能仅限特定机型。

注：● 烘烤过程中需要开门时，请不要直接面对内腔，以免烫伤！
● 开门取物时，请佩戴高温手套或使用烤盘夹，切勿直接接触高温部件。

功能说明

图示	能 功	用途（烤箱最底层为第一层）
	上部外电热管+下部电热管+对流风机	顶部和底部同时加热，后部对流风机使烤箱内部温度更加均匀。适用于在烤箱第二、三层大面积烘焙。
	上部外电热管+下部电热管	顶部和底部同时加热，烤箱内部上下热量分布均匀。适用于在烤箱第三层单层烘焙。
	下部电热管	底部加热，烤箱内部下层温度高。适用于在烤箱第一、二层烘焙。
	下部电热管+对流风机	底部加热，后部对流风机使烤箱内部温度更加均匀。适用于在烤箱第一、二层烘焙。
	上部外电热管+上部内电热管	顶部加热，烤箱内部上层温度较高。适用于在第四、五层进行大面积烧烤。
	上部内电热管	顶部加热，烤箱内部上层温度较高。适用于在第四、五层进行小面积烧烤。

烘烤参考表

甜品						
食物	功能	重量	放置层数 (由下向上)	预热时间 /min	温度 /℃	烹饪时间/min
饼干		0.5Kg	2	10	150-170	10-15
		0.5Kg	2	10	140-160	15-20
瑞士蛋卷		0.5Kg	2	10	170-190	10-15
松糕		1Kg	3	10	180-200	20-30
		1Kg	2	10	180-200	20-25
葡萄干 糕饼		0.5Kg	2	10	190-210	60-65
		0.5Kg	2	10	180-200	50-55
杯型糕饼		0.5Kg	2	10	180-200	25-30
		0.5Kg	2	10	170-190	25-30
泡芙		0.25Kg	2	10	200-220	20-25
		0.25Kg	2	10	180-220	20-25
苹果派		1Kg	3	5	150-170	50-60
		1Kg	2	5	150-170	50-60
面包片		0.3Kg	5	5	250	3
披萨		0.5Kg	3	10	230-250	15-20
		0.5Kg	3	10	210-230	15-20
烤土豆		1Kg	3	10	200-220	60-65
		1Kg	3	10	200-220	50-55

◆ 甜品烘烤说明

- 烘焙甜品时要把蛋糕置于已预热的烤箱中。
- 为防止蛋糕屑落下，烘烤过程中不要打开烤箱门。
- 建议使用黑色烘烤盘，颜色浅的烘烤盘会反射热量，面包烘烤颜色达不到金黄色。









ROBAM老板 | 电烤箱

◆ 常见问题及建议

烹饪	问题	建议
烤蛋糕	蛋糕皮太硬或干	将温度调高10度，缩短烘烤时间
	蛋糕皮脱落	少加水或将温度调低10度
	蛋糕皮烤黑	将其放到下面的搁架，调低温度，延长烘焙时间
	蛋糕里面烤的很好外面很粘	少加水，调低温度，延长烘焙时间
	蛋糕粘在盘子上	涂油在盘底，在盘底撒上面粉或垫上不透油的纸
烤面包	面包皮掉落	减少加水量
	面包底部颜色太轻	使用颜色较深的烤盘或将烤架位置降低
	夹生	降低烘烤温度、增加烘烤时间

表格中的烘烤参数只是参考，具体应根据您的经验和喜好进行调整

肉类						
食物	功能	重量	放置层数 (由下向上)	预热时间 /min	温度 /°C	烹饪时间/min
排骨		1Kg	5	5	250	12-15(一面) 12-15(另一面)
		1Kg	3	10	190-210	30-40
		1Kg	3	10	170-190	30-40
羔羊肉		1.5Kg	3	10	210-230	50-55
		1.5Kg	3	10	190-210	45-50
烤鸡		1Kg	3	5	250	30-35(一面) 30-35(另一面)
		1Kg	2	5	190-210	60-70
		1.5Kg	3	10	250	60-70
牛排		1Kg	3	10	220-240	15-20(一面) 10-20(另一面)
		1Kg	5	5	250	15-20(一面) 10-20(另一面)
		1Kg	2	5	210-230	25-35
猪排		1Kg	3	10	220-240	15-20(一面) 10-20(另一面)
		1Kg	5	5	250	15-20(一面) 10-20(另一面)

鱼类						
食物	功能	重量	放置层数 (由下向上)	预热时间 /min	温度 /℃	烹饪时间/min
烤鱼		1Kg	2	10	210-230	50-60
		1Kg	2	10	190-210	60-70
鱼片		1Kg	4	5	250	10-15
三文鱼		1Kg	3	5	210-230	20-25
真鲷		1.5Kg	3	10	180-200	30-35
		1.5Kg	3	10	170-190	25-30
鲷鱼		1Kg	3	10	170-190	15-20
		1Kg	3	10	160-180	10-15
鳕鱼		1.5Kg	3	10	190-210	25-30
		1.5Kg	3	10	180-200	20-25

◆ 肉类、鱼类烘烤说明

- 在烘烤家禽和鱼类的时候，将温度设置在180度到250度之间。
- 要烘烤外脆内嫩且多汁的牛羊肉，最好先短时间将温度设置到高温200度-220度之间，然后将温度调低。
- 当使用烤架进行烧烤时，需要将烤盘放在烤架下面，以防调料、油脂等滴到内胆上。
- 表格中标注了温度、层数和烘烤时间，但由于肉的种类、大小、肉质等的差异，可能会有偏差。
- 烧烤时需要将门关闭。

◆ 肉类、鱼类烘烤小技巧

- 使用浅色搪瓷烤盘、耐热玻璃盘或者陶瓷器皿。
- 用锡纸覆盖烤肉或鱼，可以保持水分并且保持烤箱清洁。
- 放置食物前，将烤架用油涂抹，防止食物黏贴在烤架上。

常见故障及处理方法

故障描述	可能导致故障的原因	解决办法
烤箱不工作	没有电源供应。 烤箱没有接通电源。	检查电源连接状况。 正确连接电源。
烤箱照明灯不亮	烤箱灯泡问题。 烤箱电源连接问题或保险丝烧断。	扭紧或更换新的高温灯泡。 接通电源或检查保险丝。
烤箱运行时烟冒出	烤箱内有残余油脂。	清洁烤箱内的残留油脂。
烤箱内玻璃不清澈， 有油滴现象	烘烤食物产生了油滴或水分。	烤箱冷却后清理烤箱门内 玻璃。
烤箱关门时有“咔 哒”声	烤箱门体铰链上的压舌未压紧	将铰链上的压舌用力压紧

注：以上现象仍无法排除，请与我公司特约维修点或经销商联系，严禁非专业人员对本机自行拆装。

维护和保养

 注意	清洁前必须断开电源（清洁内胆除外）。
	烤箱应该在每次使用完成后进行清洗。
	待烤箱完全冷却后再对烤箱进行清洁。对旋钮控制的机型，选择带有风扇的功能并设定时间但不设定温度时，将只有风扇运行，此功能可用于冷却烤箱。
	不能使用热蒸汽清洗烤箱。

◆ 清洁内胆

- 在碗中加入250ml水，将其放在烤箱第一层位置上，关闭烤箱门。
- 设定温度为50℃，选择底部加热功能，并设定定时器30min。
- 待功能完成后，打开烤箱门，用抹布或者海绵蘸取带有洗涤液的温水擦拭内腔。
- 清洗完成后，请将烤箱内壁擦干。

◆ 清洁面板

- 用抹布或者海绵蘸取带有洗涤液的温水擦拭面板。
- 注：对带旋钮的机型，清洁面板时，不要拔掉旋钮。

◆ 清洁门体

- 按如下步骤将门体拆下。

- 1) 将门体打开至90度。
- 2) 将烤箱左右两铰链的压舌打开至最大角度，如图1。
- 3) 轻轻关上门，待铰链转动一个合适角度后，将门体向上稍稍提起，然后向外拉即可将门体拆下，如图2。
- 4) 拆除门体上部两角处的塑料固定件，将内玻璃取下，如图3。

- 用抹布或者海绵蘸取带有洗涤液的温水擦拭玻璃。

- 按反顺序将门体装好。

注：1) 装回门体时，应确保铰链下部的凹槽正确的装到门框上的孔中。

2) 安装门体时，门体铰链上的压舌应用力压紧。

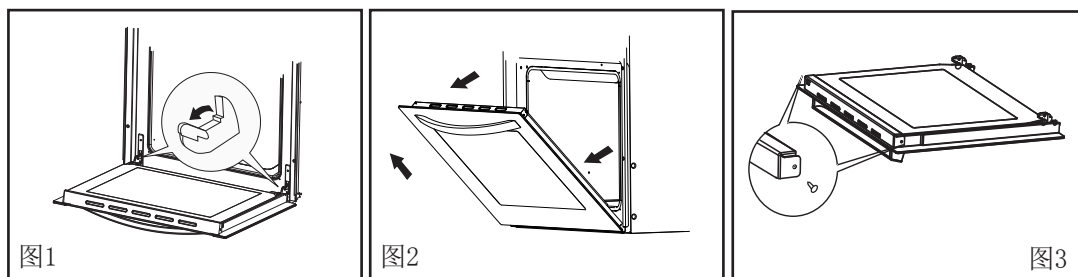

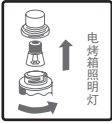
 警示	停止工作，待机器冷却后，再进行清洁保养工作。
	不得使用汽油，酒精，及其他有机溶解剂，去污粉等。以免机器变色，表面漆裂。应使用专用中性清洁剂对烤箱进行清洁养护。 
	应定期清洗烤箱，最好每次使用后都及时清洗，以免下次使用时出现油烟或异味。清洁时打开灯以便于看清烤箱表面。烤箱内膛谨记要用少量洗涤液加温水稀释后用来清洗，清洗完烤箱后立即用柔软的布擦干。
	不要用尖锐的工具清洗门体以及内胆，以免造成玻璃碎裂或划伤内胆。
	更换灯泡前确保烤箱断开电源。请确定使用耐高温灯泡或与售后服务中心联系。 
不要把过重的物体放在烤箱门上，以免损坏门体。	

ROBAM老板 | 电烤箱

电气原理图

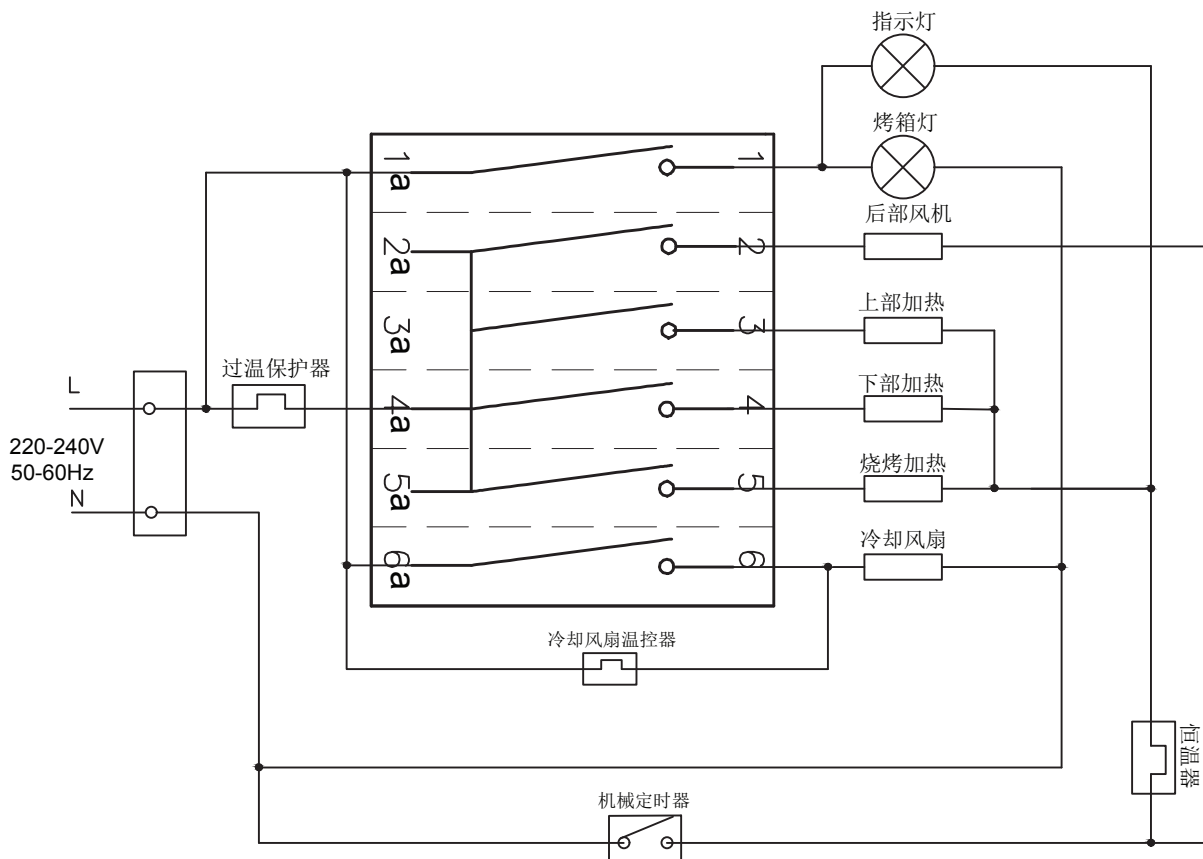

Contents



Safety Precautions	1
Product Introduction	5
Installation Instructions	7
Cleaning and Maintenance	9
Operation in case of emergency	11
Backing in the oven	12
Technical information	19
Electrical schematic Diagram	19

Safety Precautions









In order to avoid any harm or property damage to the users and other persons, following distinctions and signs are specially given.

All these are the important notices concerned with safety, so please abide by these notices strictly. And, please use this product correctly on the premise that all the contents herein are understood fully.







Distinctions on contents made in accordance with extent of harm and damage

 Danger	Personal risk, serious injury or a fire may be very likely caused if this sign is neglected and the product is operated improperly.
 Warning	Personal risk, serious injury or a fire may be caused if this sign is neglected and the product is operated improperly.
 Notice	Personal injury or damage to objects may be caused if this sign is neglected and the product is operated improperly.

Signs of the behaviors that shall be paid attention to or that shall be prohibited

 Prohibited	 No open flames	 No touch	 No remove	 Abide by strictly	 To be grounded	 Electric shock danger	 Hot surface
--	--	--	---	---	---	---	---

 **Warning** Please use this product strictly in accordance with contents of this Operation Manual. Our company is not reliable for any property loss or personal injury caused by improper using of this product.

 Danger	
 Abide by strictly	Before disconnecting plug from the socket, you should grip the end of the plug. Be sure not to disconnect the plug with power wire in your hand, otherwise such dangers as electric shock, short out and fire may be caused.
 Prohibited	Be sure not to use a power socket which is loose or contacted poorly, otherwise such dangers as electric shock, short out and fire may be caused.
 Abide by strictly	In order to avoid the electric shock that may occur, please ensure that the appliance has been disconnected from power before replacement of a bulb.
 Abide by strictly	The complete appliance shall be kept far away from heat sources and inflammables (e.g. gas and alcohol).
 Hot surface	During use the appliance becomes hot. Care should be taken to avoid touching heating elements inside the oven. when taking out foods after using, make sure to wear the high-temperature resistant protective gloves properly in order to avoid burns.

 Warning



If the supply cord is damaged, it must be replaced by the manufacturer, its service agent or similarly qualified persons in order to avoid a hazard.



Use a separate 16A or higher socket, and be sure not to connect several appliances to the same power socket at the same time, and make sure that the socket is grounded safely and effectively.



If the appliance functions improperly, make sure to disconnect it from the power and stop using immediately. And, be sure not to touch the appliance and that it is repaired by a professional.



Make sure the power cord is not damaged. When using the power cord, make sure that the cord is not bent, stretched, twisted or knotted. And, Be sure not to press or attack the power cord with weight.



You should cut off the power before cleaning of the appliance and use a neutral detergent to clean it. Moreover, make sure to clean it with a soft piece of cloth, in order to prevent its surface from being scratched.



Make sure to disconnect the electric oven from power before removing the fan guard. After cleaning, reset the guard properly to the original position in accordance with the Operation Manual.



Turn off the appliance immediately after using, otherwise the residual fat may cause a fire; in case the appliance is not to be used for an extended period of time, please cut off the power.



Hot air may come out when door of the appliance is opened after using, so please be sure not to stand too close to the appliance to avoid burns caused by the hot air.



WARNING: Accessible parts may become hot during use. Young children should be kept away.





WARNING: Ensure that the appliance is switched off before replacing the lamp to avoid the possibility of electric shock.





Do not use harsh abrasive cleaners or sharp metal scrapers to clean the oven door glass, since they can scratch the surface, which may result in shattering of the glass.

 Warning

 Never place any flammable substance (e.g. smoke agent) in or under the appliance; when using the appliance, be sure not to spray any smoke agent around it and that the appliance is always supervised.
Prohibited

 In order to prevent a fire, the appliance should be kept clean and the air duct should be kept smooth.
Abide by strictly

 Be sure not to operate the appliance when any of your hand or foot is wet or your feet are bare.
Abide by strictly

 This appliance is not intended for use by persons (including children) with reduced physical, sensory or mental capabilities, or lack of experience and knowledge, unless they have been given supervision or instruction concerning use of the appliance by a person responsible for their safety. Children should be supervised to ensure that they do not play with the appliance.
Prohibited

 Notice

 If the appliance functions abnormally, please disconnect the power plug and power it on again.
Abide by strictly

 The internal grills and ovenware, etc. should be placed properly during using.
Abide by strictly

 Be sure not to use a steam cleaner.
Prohibited

 The appliance cannot be used as an indoor heater.
Prohibited

 Use a temperature sensor recommended for this electric oven.
Abide by strictly

Product Introduction

Dear users:

We take this opportunity to express our heartfelt thanks to you for your choosing of ROBAM brand electric oven series products. We especially recommend that you shall read this Manual carefully before installing and using this product and keep it properly for later reference.

Our company is a professional corporation specializing in production of household appliances and kitchen wares such as extractor hoods, electric ovens, gas cookers and disinfectant cabinets in China. The electric oven of ROBAM brand adopts advanced design concept and optimized molding and focuses on matching with cabinet in the aspect of overall design.

Important Information

Packaging of Electric Oven

Please dispose these packaging materials in an environment-friendly way, in order to keep a good environment. Be sure not to allow children to play with the packaging materials (e.g. plastic film and carton box, etc.), otherwise it would lead to suffocation accident. So, please keep children away from the packaging materials.

Product Characteristics

- Adopts the intelligent one-touch menu for easy operation and better baking taste;
- The built-in full-automatic precise temperature probe adopts the dual temperature control technology to improve the food baking quality;
- The high-temperature enamel inner container is durable with flip heating pipes, easy to remove & clean;
- Specially made hinge integrated with the multi-layer tempered glass door, easy and flexible to open and close;
- Multi-function baking selections to meet the diverse baking demands and make it easy for operation;
- Specially designed professional baking modes with upper and lower dual temperature controls, to meet diverse baking tastes;
- Good quality baking heaters enables quick heat-up and efficient heating to extend the service life;
- Adopts the energy efficient, environmental & high-temperature resistant cotton to secure the good heat preservation performance and thus save more energy during baking.

Technical Parameters of the Product

Model	KQWS-2350-R315S
Rated Voltage	220-240V~
Rated Frequency	50-60Hz
Rated Power	2350W
Capacity	59L
Net Weight	27kg
Outside Dimension W×H×D(mm)	595×595×531

Product Structure

(The picture is for reference only, specifications are subject to the physical product)

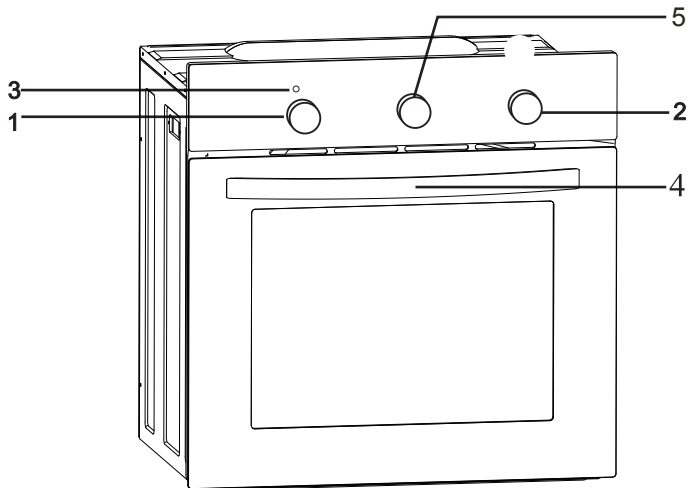

- 1 Temperature control knob
- 2 Oven function selection knob
- 3 Oven temperature signal light red
- 4 Oven door handle
- 5 Mechanical timer

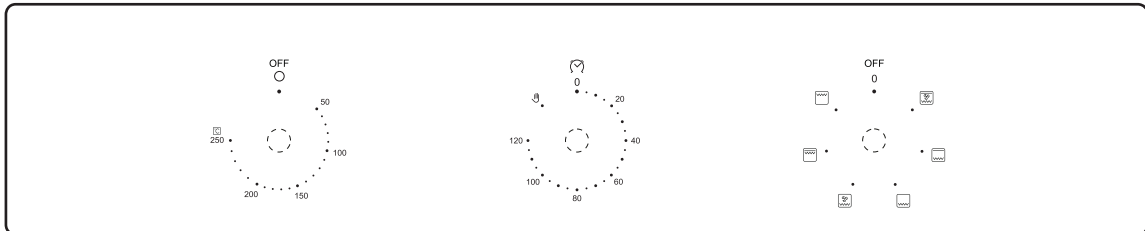

List of Accessories

S/N	Name	Quantity
1	User Manual	1 Pcs
2	Wire Rack	1 Pcs
3	Ovenware	1 Pcs
4	Mounting Screw	4 Pcs

Installation Instructions

Follow below illustration to set the square hole at the setting position of the cabinet. Insert the electric oven steadily into the square hole in place. Do not place the oven inclined.

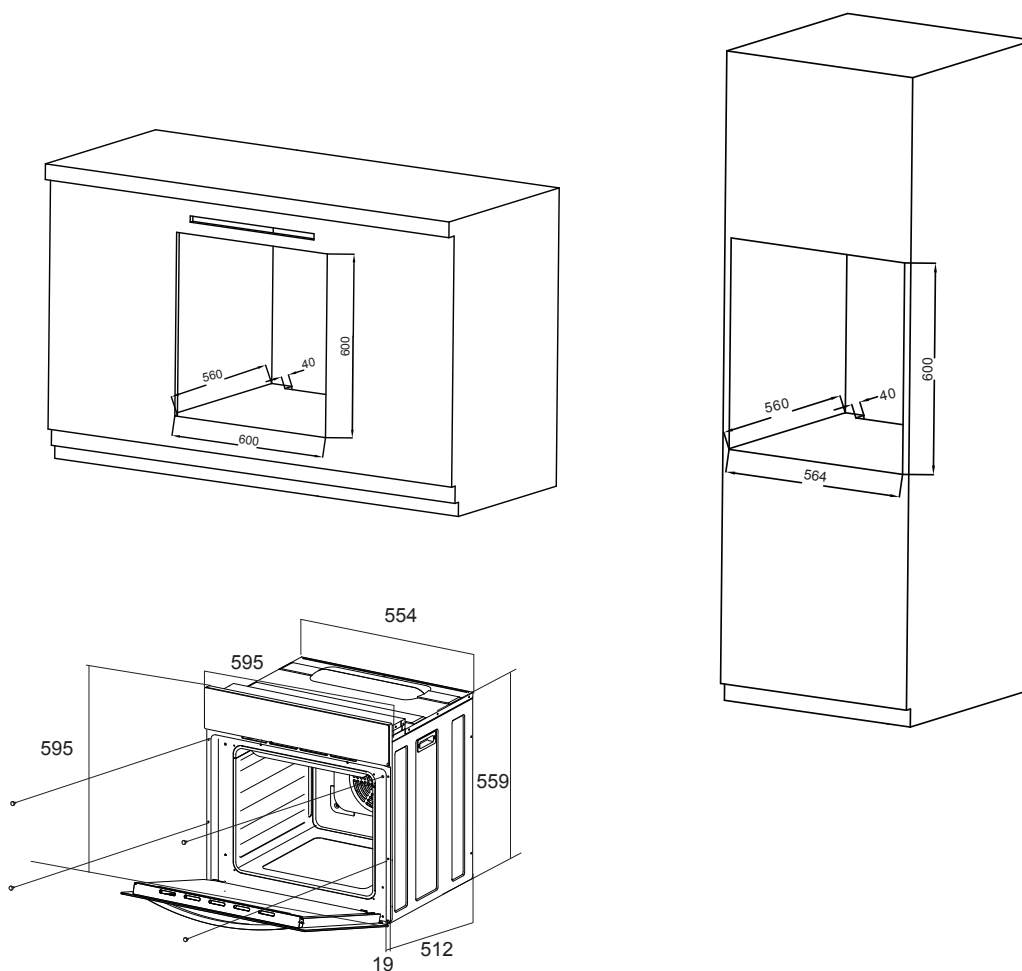

Full insertion hole diagram

Installation Requirements:

- The oven must not be installed behind a decorative door in order to avoid overheating.
- The surface where the electric oven is to be placed on should be flat and the air around the electric oven mounted in the cabinet shall be ventilated well as much as possible. It is recommended that the clamping plates and fixed plates shall adopt incombustible thermal insulation material.
- For easy connection and disconnection of power cord, be sure to disconnect the power supply at any time after the installation of the oven. a separate 16A or higher socket shall be used, be sure not to connect several appliances to the same power socket at the same time, and that the socket is grounded safely and effectively. In case there is any other electrical appliances around, please keep a 100mm or larger mounting distance.

▷ Mechanical timer

When using the oven, you must set food cooking time.

1. Turn mechanical timer to the time position you want.

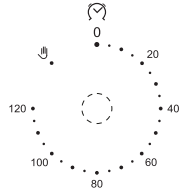

2. Turn function knob to the function position you want.

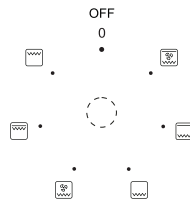

3. Turn temperature knob to the temperature position you want.

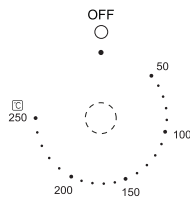

4. After above operation, oven knob runs normally.

5. When oven works till pre-set time, timer will have sound which means the cooking is finished.

If you don't want the oven work controlled by the mechanical timer, you can turn the mechanical timer to the position.

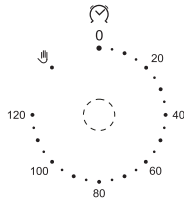

Caution!

Don't turn mechanical timer in a clockwise way from 120 to "0".

▷ Oven

Oven is controlled by the function knob and the temperature control knob.

Caution!

When selecting any heating function the oven will be switched on only after the temperature has been set by the temperature control knob.

Possible settings of the oven function knob



Full Grill

This function allows a higher temperature at the top of the cooking area, which causes more intense browning of the dish and permits larger portions to be grilled.

Warning!

When using function Grill it is required that the oven door is closed.

Warning!

When the grill is in use accessible parts can become hot. It is best to keep children away from the Oven.



Bottom element

At this oven function knob position, the oven activates the bottom element.



Fan and bottom heater on

At this oven function , the oven activates the bottom heater and fan function. The mode is useful for baking low pastry and preparation of preserved fruit and vegetables.



Bottom and top element on

Setting the knob to this position allows the oven to be heated conventionally.



Fan, bottom and top element on

At this knob position the oven executes the cook function. Conventional oven with a fan.



Grill heater on

Setting the knob to this position allows dishes to be grilled on the grate.

Warning!

When using function grill it is recommended that the oven door is closed.

When the grill is in use accessible parts can become hot. It is best to keep children away from the oven.

CLEANING AND MAINTENANCE

Caution!

When the functions with fan have been selected but the temperature knob is set to zero only the fan will be on. With this function you can cool the dish or the oven chamber.

Oven guide levels

Baking pans and accessories (oven grid, baking tray, etc) may be inserted into the oven at 5 shelf position.

Appropriate levels are indicated in the tables that follow.

Always count levels from the bottom upwards!

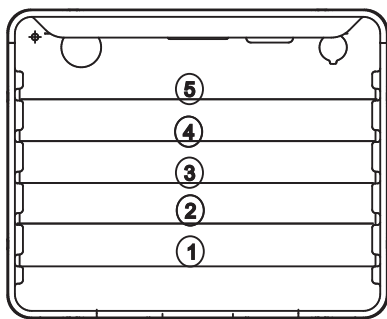

By ensuring proper cleaning and maintenance of your oven you can have a significant influence on the continuing fault-free operation of your appliance.

Before you start cleaning, the oven must be switched off and you should ensure that all knobs are set to the "0" position. Do not start cleaning until the oven has completely cooled.

▷ **Oven**

- The oven should be cleaned after each use.
- Cool the oven completely before cleaning.
- Never clean the appliance with pressurized hot steam cleaner.
- The oven chamber should only be washed with warm water and a small amount of washing-up liquid.
- **Steam cleaning**
 - pour 250m l of water (1 cup) into a bowl placed in the oven on the first level from the bottom.
 - Close the oven door.
 - Set the temperature knob to 100 °C, and the function knob to the bottom heater position.
 - Heat the oven chamber for approximately 30 minutes.
 - Open the oven door, wipe the chamber inside with a cloth or sponge and wash using warm water with washing-up liquid.
- After cleaning the oven chamber wipe it dry.

Caution!

Do not use cleaning products containing abrasive materials for the cleaning and maintenance of the glass front panel.

▷ Changing the Oven Lamp

Before any maintenance is started involving electrical parts, the appliance must be disconnected from the power supply . If the oven has been in use, let the oven cavity and the heating elements cool down before attempting any maintenance.

Changing the bulb

- Unscrew the protective cover. We recommend that you wash and dry the glass cover at this point.
- Carefully remove the old bulb and insert the new bulb suitable for high temperatures (300°C) having the following specifications: 220-240V, 50-60Hz, 25W, G9 fitting.
- Refit the protective cover.

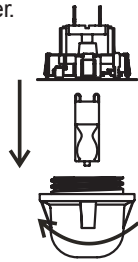

IMPORTANT

Never use screwdrivers or other utensils to remove the light cover . This could damage the enamel of the oven or the lampholder . Remove only by hand.

IMPORTANT

Never replace the bulb with bare hands as contamination from your fingers can cause premature failure. Always use a clean cloth or gloves.

Please note:

The bulb replacement is not covered by your guarantee

▷ Door removal

In order to obtain easier access to the oven chamber for cleaning, it is possible to remove the door.

To do this, tilt the safety catch part of the hinge upwards. Close the door lightly, lift and pull it out towards you.

In order to fit the door back on to the cooker, do the reverse. When fitting, ensure that the notch of the hinge is correctly placed on the protrusion of the hinge holder. After the door is fitted to the oven, the safety catch should be carefully lowered down again. If the safety catch is not set it may cause damage to the hinge when closing the door.

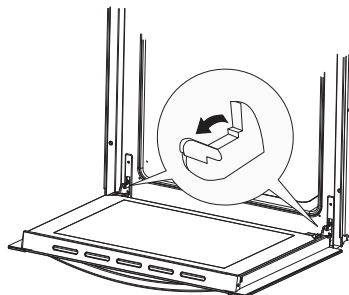

Tilting the hinge safety catches

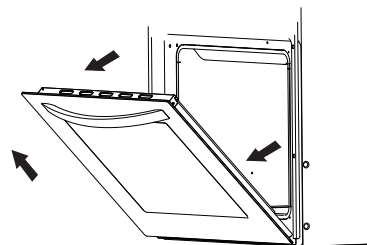

Door removal

▷ **Removal of the internal glass panel**

Press the symbol “↑” and outward the plastic latch that is in the corner at the top of the door. Next take out the glass from the second blocking mechanism and remove. After cleaning, insert and block the glass panel, and insert in the blocking mechanism.

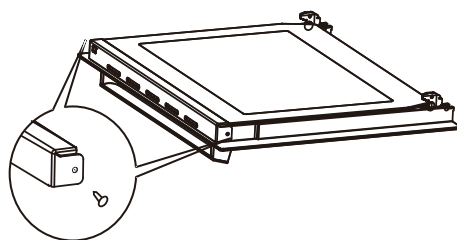

Removal of the internal glass panel

▷ **Install door**

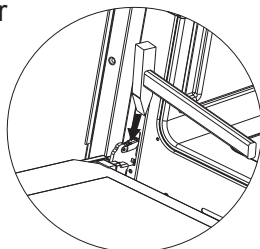

OPERATION IN CASE OF EMERGENCY

In the event of an emergency, you should:

- Switch off all working units of the oven
- Call the service centre
- Some minor faults can be fixed by referring to the instructions given in the table below. Before calling the customer support centre or the service centre check the following points that are presented in the table.

PROBLEM	REASON	ACTION
1. The appliance does not work.	Break in power supply.	Check the household fuse box; if there is a blown fuse replace it with a new one
	Choose wrong function.	Check if function knob ,temperature Knob is set to the correct position.
2. The programmer display is flashing"0.00".	The appliance was disconnected from the mains or there was a temporary power cut.	Set the current time (see Use of the programmer)
3. The oven lighting does not work.	The bulb is loose or damaged.	Tighten up or replace the blown bulb (see Cleaning and Maintenance)

BACKING IN THE OVEN

▷ Baking pastry

Most appropriate position for baking is the application of both upper and lower heater, or the hot air.

Warning!

- The baking parameters given in Tables are approximate and can be corrected based on your own experience and cooking preferences;
- In case you may not find any particular type of cake in the tables, use the information available for the next most similar type of cake.

Baking with upper and lower elements

- Use only a single guide level.
- This baking position is especially suitable for baking dry pastry, bread and teacakes. Use dark baking pans. Light pans reflect heat and pastry is not adequately browned.
- Always place baking pans on the grid rack. Remove the grid only if baking in the flat biscuit tray, supplied with the appliance.
- Preheating shortens the baking time. Do not put the cake in the oven until proper temperature is obtained.

Baking tips

Is cake baked?

Pierce the cake with a wooden skewer at the thickest part, if the dough does not stick to it, the cake is baked. You may switch off the oven and use the remaining heat.

Cake has fallen

Check the recipe. Use less liquid next time. Follow the mixing times, especially when using electric kitchen mixers.

Cake is too light on the bottom

Use dark baking pan next time, or place the pan one level lower, or switch on the lower heater a while before the completion.



Cheese cake is undercooked

Next time reduce the baking temperature and extend the baking time.

Warnings regarding the baking tables

- The tables indicate the temperature range. Always select lower temperature first. You may always increase the temperature in case pastry needs more baking.
- Baking times are indicative only.
- The asterisk indicates that the oven requires preheating.

Pastry Baking Table

Type of pastry	Guide level (from down upwards)	Temp (°C) 	Guide level (from down upwards)	Temp (°C) 	Baking time (in min.)
Sponge cake/marble cake	2	170-180	2	160-170	60-80
Victoria sponge	2	160-180			65-80
Base for a layer cake	2-3	170-180			20-30
Sponge layer cake	2	170-180			30-40
Fruit cake(crispy base)			3	160-170	60-70
Cheesecake(shortcrust)			3	160-170	60-90
Teacake	2	160-180			40-60
Bread(e.g.wholegrain bread)	2	210-220	3	180-210	50-60
Fruit cake(crispy base)	3	170-180	3	160-170	35-60
Fruit cake(with yeast)					30-50
Crumble cake	3	160-170			30-40
Sponge roll	2	180-200			10-15
Pizza(thin base)	3	220-240	3	200-220	10-15
Pizza(thick base)	2	180-210	3	210-230	30-50
Puff pastry	3	180-190	3	160-170	18-25
Meringues	3	90-110			80-90
Choux buns					35-45

▷ Roasting

Best results are obtained with the engagement of both upper and lower elements. Best heating mode for each type of roasting pan is indicated by bold print in the Roasting Tables.

Tips regarding roasting pans



- For best results, use light enamel pans, temperature resistant glass pans, clay dishes or cast iron dishes.
- As stainless steel dishes reflect the heat, they are not recommended.
- If you cover your roast or wrap it in foil, it will preserve its juices and the oven will remain clean.
- The roast will be cooked quicker if it is left uncovered. Large roasts can be placed directly on the grid with the oven tray below for catching the juices and melted fat.

Attention when roasting!

Roasting tables indicate suggested temperatures, guide level and roasting times. Roasting time largely depends upon the type of meat, its size and quality. So you may expect some variations

- Roasting of large chunks of meat may produce excessive steaming and condensation on the oven door. This is quite normal, and does not affect the operation of the oven. However, after the completion of roasting wipe the oven door and the glass thoroughly.
- Add as much liquid as necessary to prevent burning of juice, dripping from meat. Roast must be checked regularly and liquid added if necessary.
- At approximately the middle of the indicated time turn the roast round, especially if you use the deep roast dish.
- When roasting on the grill grid, place the grid in the deep roasting pan and insert both into the sliding guide. The bottom pan will intercept dripping fat.
- Never leave roast to cool in the oven, as it might produce condensation and corrosion of the oven.

Roasting table

Type of meat	Guide level (from bottom up)	Temp (°C) 	Guide level (from bottom up)	Temp (°C) 	Roasting time (in min.)
Beef					per 1 cm
Roast beef or fillet rare			2	220-230	12-15
Oven warmed up juicy (medium)					12-25
Oven warmed up "well done"					25-30
Oven warmed up Roast joint	2	160-180			120-140
Pork					
Roast joint	2	160-180	2		90-140
Ham	2	160-180			60-90
Fillet					25-30
VEAL	2	160-170	2	180-200	90-120
LAMB	2	160-180			100-120
VENISON	2	175-180	2	180-210	100-120
POULTRY					
Chicken	2	170-180			50-80
Goose(approx.2kg)	2	160-180	2	150-160	150-180
FISH	2	175-180	2	170-200	50-80

▷ Grilling

- Take extra precautions when grilling. Intensive heat from infrared element makes the oven and the accessories extremely hot. Use protective gloves and barbecue accessories!
- Perforated food may produce spurting of hot grease (e. g. sausages). Use long grill tongs to prevent skin burns and protect your eyes.
- Supervise the grill at all time. Excessive heat may quickly burn your food and provoke fire!
- Do not let the children in the vicinity of the grill.

Grill heater is especially suitable for the preparation of low-fat sausages, meat and fish fillets and steaks, and for browning and crisping the roast skin.

Tips for grilling

- Grilling should be carried out with the oven door closed.
- Grilling tables indicate the recommended temperature, guide levels and grilling times, which may vary according to the weight and quality of meat
- Grill element should be pre-heated for 3 minutes.
- Oil the grill grid before placing food on it, to avoid food sticking to the grid.
- Place the meat on the grid, then place the grid on the grease interception pan. Insert both trays into the oven guides.
- Turn the meat round after half of the grilling time has expired. Thinner slices will require only one turn, for larger chunks you might need to repeat the procedure. Always use barbecue tongs to avoid losing excessive juice from meat.
- Dark beef meat is grilled quicker than lighter pork or veal.
- Clean the grill, the oven and the accessories each time after use.

Grill table

Type of meat for grill	Weight (in grams)	Guide level (from bottom up)	Temp (°C) 	Grill time (in min.)
Meat and sausages				
2 beefsteaks, rare	400	5	240	14-16
2 beefsteaks, medium	400	5	240	16-20
2 beefsteaks, well done	400	5	240	20-23
2 veal steaks	700	5	240	19-22
4 lamb cutlets	700	5	240	15-18
4 grill sausages	400	5	240	9-14
2 slices of meat cheese	400	5	240	9-13
1 chicken, halved	1400	3	240-240	28-33(1.side) 23-28(2.side)
Fish				
Salmon fillets	400	4	240	19-22
Fish in aluminium foil	500	4	230	10-13
Toast				
4 slices of white bread	200	5	240	1.5-3
2 slices of whole meat	200	5	240	2-3
Toast sandwich	600	5	240	4-7
Meat/poultry				
Chicken	1000	3	180-200	60-70
Roast beef/beef fillet	1500	3	190-200	40-80

TECHNICAL INFORMATION

Model	KQWS-2350-R315S
Voltage rating	220-240V 50-60Hz
Total power	2350W
Top element	1100W
Grill element	850W
Bottom element	1150W
Circular element	/
fan	●

Electrical Schematic Diagram

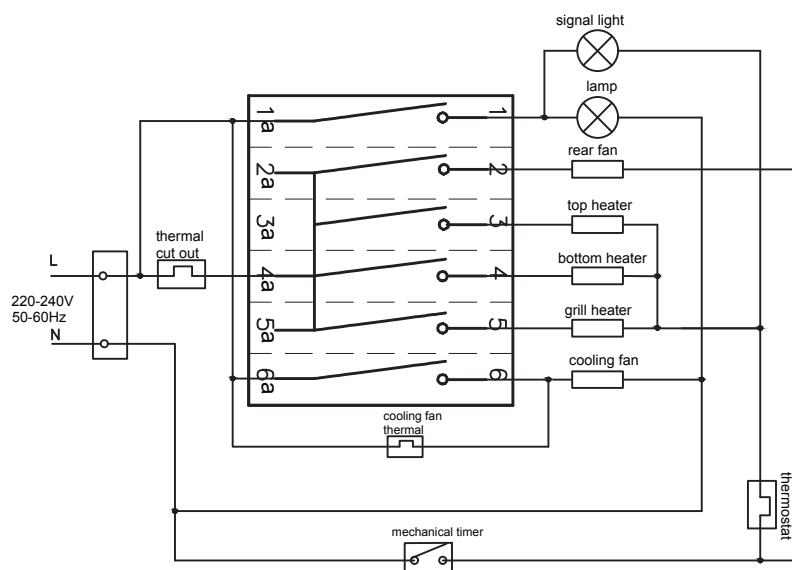

Edition: A/0
2019.12.28

ROBAM