

ROBAM



User Manual

Before operating this unit, please read the user manual completely and keep it. If the manual is lost, you can send e-mail to overseas@robam.com, request for an electronic manual.

CXW-260-77H1S

Range Hood

CONTENTS

Safety Precaution.....	1
Important Information.....	4
Product Description.....	5
Packing List.....	5
Installation.....	6
User Manual.....	10
Maintenance.....	12
Removal of Components.....	13
Circuit Diagram.....	15
Troubleshooting of General faults.....	15

Dear users:



Thank for your buying our range hood. Please accept our best regards. Please read this user manual carefully before installation and operation.

*The pictures in this manual only for your reference. If the picture isn't accord with object, subject to object. We keep to right to update appearance, structure or products without notice.

Safety Precaution

In order to avoid harm or property damage to the users or other person, the following distinction and marks are stipulated. They are important safety precaution, please comply strictly based on the full understanding.

Subject to harmful or destruct degree







 Danger	If ignore this sign and operate product improperly, it's highly possible to cause danger, serious injury or fire.
 Warning	If ignore this sign and operate product improperly, it's possible to cause danger, serious injury or fire.
 Notice	If ignore this sign and operate product improperly, it's possible to cause injury or loss.

Notice and Prohibit Mark



 Prohibit	 Prohibit Flame	 Prohibit Touch	 Prohibit Touch by Wet Hand	 Prohibit Disassembly	 Strict Execution	 Necessary Earthed	 Caution Electric Shock	 Caution Scald
---	--	--	--	--	--	--	--	---

 Warning Please use this product according to manual strictly, or ROBAM shall not take any responsible caused by improper operation.









Danger

 Prohibit	Don't allow children or weakling to use range hood separately, or it may cause electric shock or other accident.
 Prohibit	Prohibit water on motor, switches or other electric parts; Prohibit wash range hood by water spray. Don't use range hood if wet or it may cause electric leakage or shock.
 Prohibit	Don't change, stretch, bind or press electric wire, or it's possible to cause electric shock or fire because of broken wire.
 Prohibit	Prohibit any change of interior circuit, or it may cause injury or other danger, for example, electric shock or fire.
 Prohibit Touch by Wet Hand	Don't touch plug, electric parts or button by wet hands, or it may cause electric shock.
 Strict Execution	Unplug before cleaning, installing or maintaining, avoiding from electric shock.









Danger

 Strict Execution	<p>Please turn off range hood immediately if pan got fire (range hood shall aggravate fire if it's working) and extinguish fire by effective action. For example, cover flame by metal cover, turn off gas valve immediately and remove inflammable things.</p>
 Strict Execution	<p>Any abnormal, please turn off power, take off plug or cut off electric source, and contact service. It's possible to cause electric shock or fire if using range hood under abnormal situation.</p>



Warning

 Prohibit Disassembly	<p>Range hood must be installed, disassembled or maintained by professional person.</p>
 Prohibit	<p>Stove fire shall be extinguished timely when it is not used; do not flambe under the range hood and it's prohibited to bake food under range hood directly to prevent range hood from damaging and causing accidents.</p>
 Prohibit Touch	<p>Don't touch bulb if it's on or just close in short time, or it may cause scald.</p>
 Strict Execution	<p>In order to ensure safety, range hood must be installed by specific accessory (especially expansion pipe and wooden screws, or it may cause accidental drop of range hood). The pipe bore and hole must fit tightly during the installation of metal expansion pipe. It is prohibited to make excessively large hole to prevent accidental drop of loosening expansion pipe.</p>
 Strict Execution	<p>The range hood must be used by specific plug and properly ground it. It's possible to cause electric shock, hot plug or fire because of improper electric wire. Installation must be executed by professional person based on local electrical regulations. Before connect electricity, power must be turned off.</p>
 Strict Execution	<p>If the supply cord is damaged, it must be replaced by the manufacturer, its service agent or similarly qualified persons in order to avoid a hazard.</p>
 Strict Execution	<p>All operation must comply with our safety guidelines as well as local safety regulations.</p>
 Strict Execution	<p>There shall be adequate ventilation of the room when the range hood is used at the same time as appliances burning gas or other fuels.</p>
 Strict Execution	<p>This appliance just for household use only. And it's not allowed to exhaust dangerous or explosive matter or air. It should be put under dry and ventilation environment without dangerous air.</p>







Warning

 Strict Execution	<p>The range hood and electric circuit must be installed by skilled and trained personnel with required qualification. When installation, the related regulation, standard or instruction on fire must be complied. It may cause danger because of improper installation, for example, electric shock, drop or fire accident.</p>
 Strict Execution	<p>The outlet must be connect with outside. In order to ensure safety and fresh air, waste gas should be exhaust to outside. Don't exhaust waste gas to the wall, loft or garage.</p>
 Strict Execution	<p>There is a fire risk if cleaning is not carried out in accordance with the instructions.</p>
 Strict Execution	<p>Keep a good habit to turn off gas hob and gas valve if go outside, sleep or finish operation. Replace or check gas pipe regularly, since gas alarm device can't completely avoid accident caused by gas leakage.</p>
 Strict Execution	<p>This appliance is not intended for use by persons (including children) with reduced physical, sensory or mental capabilities, or lack of experience and knowledge, unless they have been given supervision or instruction concerning use of the appliance by a person responsible for their safety. Children should be supervised to ensure that they do not play with the appliance.</p>
 Strict Execution	<p>The minimum distance between the supporting surface for the cooking vessels on the hob and the lowest part of the range hood. When the range hood is located above a gas appliance, this distance shall be at least 650mm. If the instructions for installation for the gas hob specify a greater distance, this has to be taken into account.</p>
 Strict Execution	<p>Range hoods and other cooking fume extractors may adversely affect the safe operation of appliances burning gas or other fuels (including those in other rooms) due to back flow of combustion gases. These gases can potentially result in carbon monoxide poisoning. After installation of a range hood or other cooking fume extractor, the operation of flued gas appliances should be tested by a competent person to ensure that back flow of combustion gases does not occur.</p>
 Strict Execution	<p>The range hood is only intended to be installed over a hob with no more than four hob elements.</p>

Notice

 Prohibit	<p>The air must not be discharged into a flue that is used for exhausting fumes from appliances burning gas or other fuels, the discharge of air must fulfill the requirements of local regulations.</p>
 Strict Execution	<p>Before removing range hood for installation, clean or maintainance, power must be cut off avoiding from electric shock. When installation, clean or maintainance, protective gloove must wear avoiding from injury.</p>

Notice

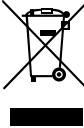
 Strict Execution	<p>The temperature for range hood working can't exceed 40°C.</p>
 Strict Execution	<p>Because the installation is difficult and hood is heavy, the installation shall be executed by professional person based on manual.</p>
 Strict Execution	<p>Don't break electric wire or other invisible equipment when cutting something or drilling holes on ceiling.</p>
 Strict Execution	<p>When range hood is using in well sealed building, it should have air inlet or open door to ensure good ventilation.</p>
 Strict Execution	<p>When the oil exceeds 2/3 or near tick mark in the oil cup, clean it in time. Don't eat waste oil from oil cup.</p>
 Strict Execution	<p>The wall of installing range hood needs enough strength. For hollow walls, the thickness of solid layer of hollow wall must be more than 30mm, but for concrete walls, it can be drill holes directly. The range hood must be fixed on the wall firmly.</p>
 Strict Execution	<p>CAUTION: Accessible parts may become hot when used with cooking appliances.</p>
	<p>DISPOSAL: Do not dispose this product as unsorted municipal waste. Collection of such waste separately for special treatment is necessary. This product must not be disposed together with the domestic waste. This product has to be disposed at an authorized place for recycling of electrical and electronic appliances. By collecting and recycling waste, you help save natural resources, and make sure the product is disposed in an environmental friendly and healthy way.</p>

Important Information

Package of Range Hood

Please settle those packages carefully in order to protect environment. Don't allow children to play plastic film and package, it may cause asphyxia. Please avoid children near package material.

Before use Range Hood

This range hood exhaust fume outside. Please read this manual and all information carefully before installation and operation. Please comply with our suggestion. If it's necessary, please read manual for gas hob. And please keep these manual carefully for future reference. If range hood has obvious damage, please don't electrify and contact operator.

Product Description

Technical Data

Model	CXW-260-77H1S	Noise	53dB (A)
Rated Voltage	220-240V~	Rated Power Input	264W
Rated Frequency	50-60Hz	Turbo Power	304W
Airflow(Turbo)	1440m ³ /h	Rated Main Motor Power Input	260W
Max static pressure	1000Pa	Lamp Power(max)	2W×2
Net Weight	26kg	Dimension (L×W×H)	(895×203×470)mm

- Note: 1. The performance test results are all in 230V~ 50Hz power supply environment. The airflow in according to IEC61591-2019, the noise in according to IEC60704.
2. The determined value of airflow,max static pressure shall not be less than 90% of declared value.
3. The noise declared value shown is A weighted sound pressure level.
4. The above performance parameter data are tested under the mode of shutting down the Intelligent Sense Constant Suction Mode, and the mode of shutting down the Intelligent Sense Constant Suction Mode is the normal airflow mode.

Body Size

The marked sizes are for reference only, the depth dimension includes machine feet. (Unit: mm)

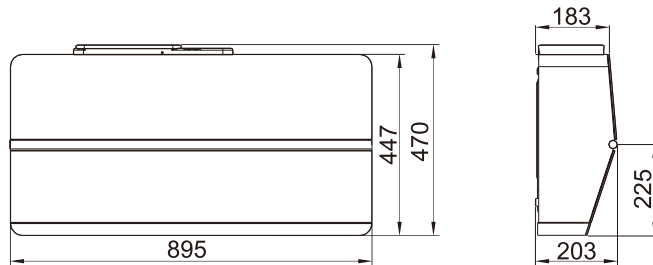

Packing List

Please check the items in the container upon unpacking

Packing List	No.	Name	Quantity	No.	Name	Quantity
	1	Range hood	1	4	Check valve	1
	2	Ø185(outer diameter) aluminum foil exhaust pipe	1	5	Oil cup	1
	3	User manual	1	6	Accessory packs	1

Installation

 If the flue aperture is less than air duct aperture, it will influence the fume suction effect and the too long air duct will influence the fume suction effect, too.

Preparation for installation

● Surrounding

Keep the hood away from too many doors and windows, so as to avoid air convection affecting the efficiency.

● Tools preparation

The hood will be installed with the following tools

1. an impact drill (with drill bit); 2. a wrench; 3. a screwdriver; 4. a ruler.

Notice

- Installation and circuit setting must be done by experienced professionals. Only a professionally trained person with an installation qualification can install the hood. Non-professionals are not allowed to install, dismantle and repair the hood.
- Please do not power on the hood before installation to avoid electric shock.
- Do not expose the hood if your kitchen is under renovation, because construction materials, dusts, paint, coatings, and emitted gases will corrode and tarnish the hood surface. Therefore, it is recommended to install it after the renovation is completed.
- If you need move the Gas Hob before installing the Range Hood, please close the main valve before moving the Gas Hob.
- Don't install the hood on wood and other combustible walls. The wall shall be made of noncombustible materials with enough strength and the surface shall be flat.
- The hood may have very sharp edges. So, please wear protective gloves during hood installation, cleaning or repair.
- When drilling on the wall or ceiling board, keep away from embedded wires and other concealed devices to avoid electric shock and fire.
- Do not install the hood at a too high position as well as keep the hood free from disturbance of ambient airflow lest the reduction of smoke pumping effect shall occur.
- When making cabinet, please leave space for installation and disassembly of the hood in order to maintain and overhaul the hood.
- When installing, please keep the machine body remain horizontal.
- Please use single phase grounded socket and the hood shall be well grounded (water pipe grounding is not reliable and gas pipeline grounding has risks of causing fire disaster and explosion).
- In order to ensure safety and successful installation, please use standard accessories provided with the hood for installation, otherwise the hood may be at risk of falling down.
- If the power cord is damaged, in order to avoid danger, it must be replaced by manufacturer, professionals of its maintenance department or similar departments. Please do not carry out restructuring, stretching, knotting and squeezing or apply heavy objects to the power cord, etc., otherwise it may cause power cord damage easily, leading to accidents such as electric shock and fire disaster, etc.
- After installation, please clean the surface of the hood, and then supply power for test run.

Installation

Note: All data units in the following diagram are expressed in mm.

● Determine the position

In order to ensure a good operating experience, it is recommended that the top of the hood is flush with the bottom of the hanging cabinet, and the distance between the bottom of the hanging cabinet and the countertop is ≥ 800 mm. The following three installation methods are listed according to the reserved size of the hanging cabinet on the top of the hood, and the preferred option is a.

a. Installation method when the width of hanging cabinet is more than 900mm (the following installation method is 900mm for example), the actual opening size is adjusted according to the width of the cabinet.

Cabinet reserved dimensions as shown in Figure 1, cabinet and ceiling opening dimensions as shown in Figure 2 and Figure 3, the socket location is recommended to be installed above the ceiling.

Figure 1

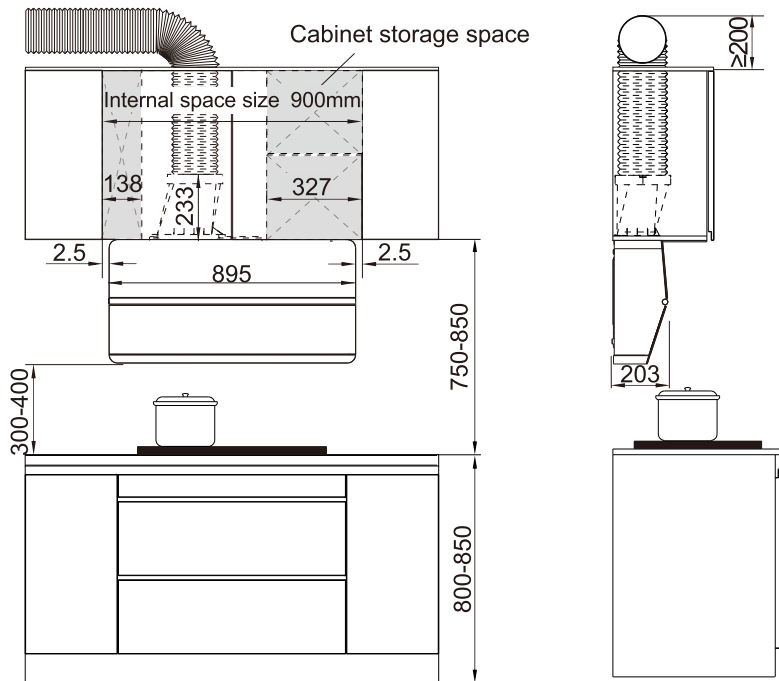
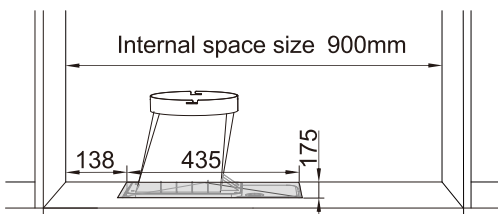
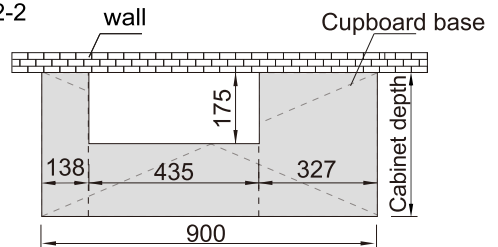

Figure 2-1



Cabinet movable baseboard opening dimension drawing

Figure 2-2



Projected dimensions of movable base plate (shaded space for storage)

Figure 3

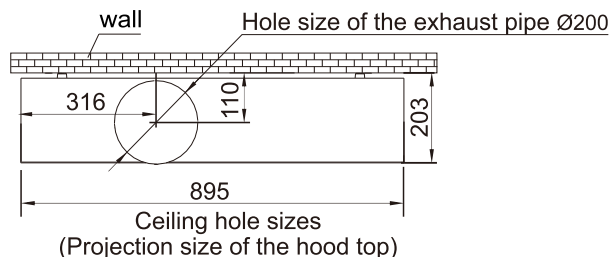

b. Installation without hanging cabinets

Cabinet prep dimensions are as shown in Figure 4, ceiling opening dimensions are as shown in Figure 3, and outlet locations are recommended to be installed above the ceiling.

Figure 4

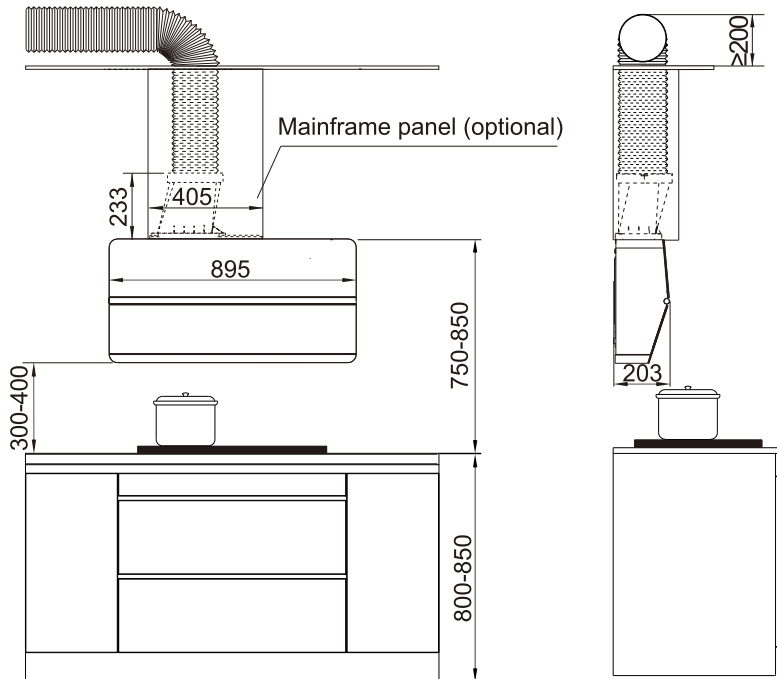

c. Installation method when the width of hanging cabinet is 435-900mm (the following installation method takes 450mm as an example)

Cabinet prep dimensions are shown in Fig. 5, cabinet and ceiling opening dimensions are shown in Fig. 6 and Fig. 3, and outlet locations are recommended to be installed above the ceiling.

Note: If you use this solution to install, users need to purchase special hooks, please contact the after-sales service center for specific installation.

Figure 5

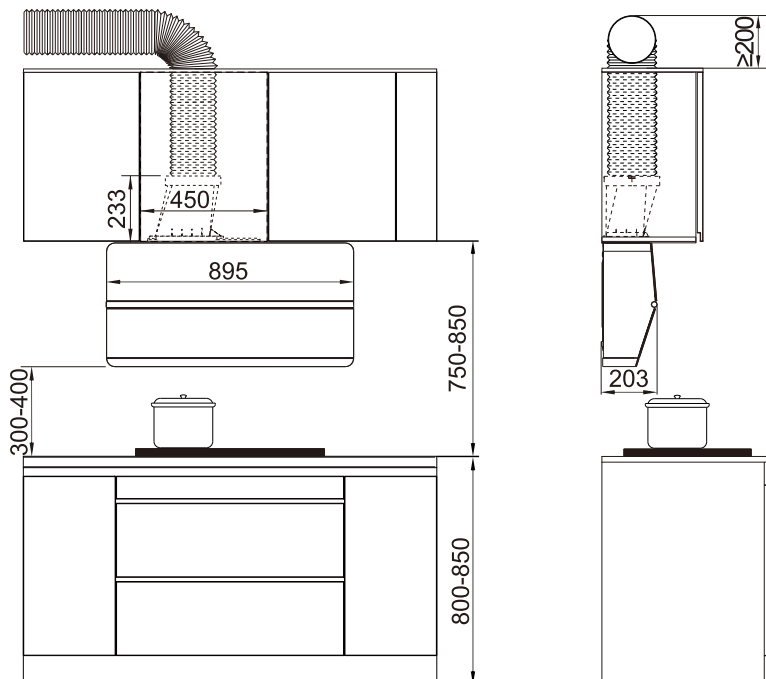
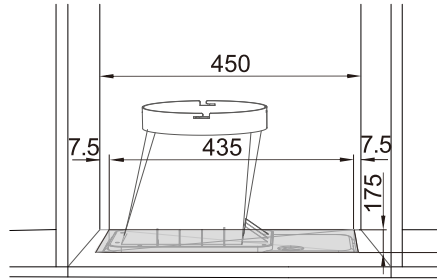

Figure 6



Cabinet movable baseboard opening dimension drawing

● Install pothook

According to the size of the pothook in the corresponding position on the wall, with a diameter of 10mm drill bit drilling depth of 60mm-70mm four holes (not too large), the expansion pipe will be pressed into the holes, and then with the randomly equipped 4 cross countersunk head wood screws to hang the pothook fixed reliably. At a distance of 55mm from the height of the four holes, drill a diameter of 10mm (not too large), the depth of 50mm-55mm limit block mounting holes, the M6 metal expansion tube into the hole.

(Figure 7)

Figure 7

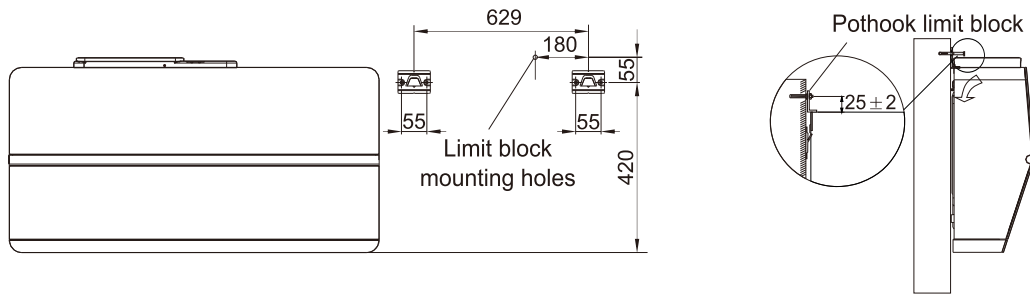

● Install hood body

Fix the air outlet seat as shown in Fig. 9, press and slide the hanging holes at the rear of the body against the hooks of the hanging feet as shown in Fig. 7, and shake the body by hand to see if it hangs firmly. After the body is installed in place, install the pothook limit block and spacer on the M6 metal expansion tube, and tighten the nut (to prevent the body from accidentally unhooking under external force).

Install the aluminum foil exhaust pipe

● Drilling position of the aluminum foil exhaust pipe (public flues do not require drilling)

- aluminum foil exhaust pipe and hob facing the window: Remove one of the glasses and install a plywood with ventilation holes or punch directly on the glass.
- Hob away from the window: Install the aluminum foil exhaust pipe through the window that is close to the hob and connected outside; or install it by punching on the wall that is close to the hob and connected outside.
- Drill hole through the wall: Determine the location of the aluminum foil exhaust pipe against the wall and draw the drilling range (i.e. a circle slightly larger than the pipe OD). Then use a long drill bit to drill through the wall. Pay attention to the wall structure and material, so as not to destroy other parts of the wall.

● Link the aluminum foil exhaust pipe

First, straighten the aluminum foil exhaust pipe, put the end without duct fixing strip on the public flue interface and tape it (if there is no public flue, please pull the duct directly to the outdoor). When the public flue interface or wall hole is larger than the aluminum foil exhaust pipe, it can be directly connected, when it is smaller than the duct, you can choose the duct interface. First, put one end of the aluminum foil exhaust pipe without duct fixing strip on the duct interface with tape, and then connect it with the public flue interface. The small end of the duct connector has five specifications: 140mm, 150mm, 160mm, 170mm, and 180mm outside diameter, and the excess part smaller than the public flue connector or wall hole can be cut off according to the actual situation.

Then, put the four clips of the air outlet seat interface into the four slots of the air outlet seat and rotate clockwise to fix it. Finally, insert the end of the aluminum foil exhaust pipe with the duct fixing strip into the outer ring of the air outlet seat interface, fix it with three ST4.2×8 screws in a distribution, and seal it with duct tape.

Figure 8

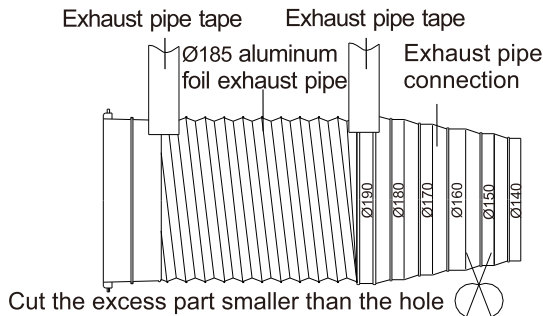

Note: During installation, straighten the aluminum foil exhaust pipe to avoid noises in semi-stretched state. Excess part may be cut with a wire cutter.

The exhaust wall hole diameter shall be close to that of the exhaust pipe, which shall not be too small. Otherwise, it will cause poor exhaust efficiency, more noises and lower volume, etc. The connection between the pipe and the hole or the public flue must be sealed tightly to ensure that the pipe and the check valve or public flue is connected securely. The blades at the public flue connection must be flexible. Recommendation: When the range hood is matched with the anti-smoke back check valve, there is no need to install the range hood with its own check valve blade. If the use of the self-contained air outlet seat blade, in the switching machine may appear blade open and close the sound, is a normal phenomenon.

Figure 9

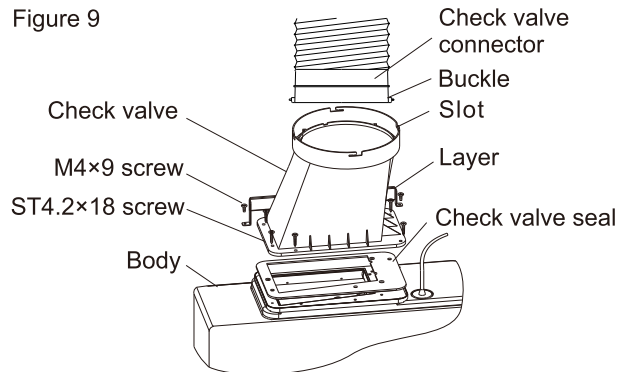

Note: Install with the adhesive side of the air outlet seat seal facing up.

User Manual

Switch control panel

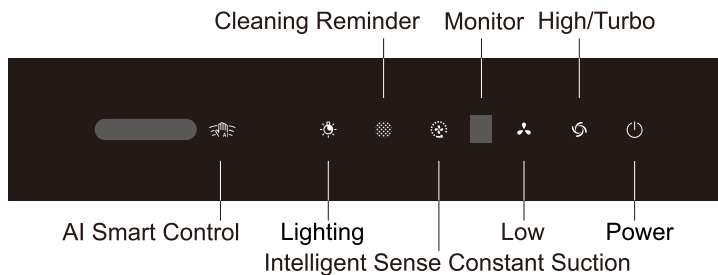





Turn on the power, the buzzer sounds to indicate the power-on state.



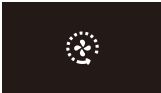

Power

Press the power key to enter the power-on state and the power key icon is long lit.

- ① In the fan not running state, press the power key to enter the shutdown state;
- ② In the fan running state, press the power key, the hood enters the delayed shutdown state, 1 minute after the automatic shutdown of all functions; in the delay process, in accordance with the lighting key, the wind volume key, the intelligent sense of constant suction key, long press the cleaning reminder key, AI smart Control, the effective combination of keys can be canceled to delay the shutdown, if you press the power key, then shut down all the features;
- ③ In the power-on state, if there is no operation within 3 minutes, it will enter the power-off state.

 <p>High/Turbo</p>	<p>When the power key is turned on, in normal airflow mode (intelligent sense constant suction icon is off):</p> <ol style="list-style-type: none"> ① Press the high/turbo key, the high/turbo icon lights up, and it enters the high operation state. At this time, the display shows "6"; ② And then press the high / turbo key, high / turbo icon flashes, the fan starts turbo . At this time, the display shows "9"; nearly 3 minutes after the automatic switch to the high running state; ③ Press this key repeatedly to cycle the fan between "high - turbo ".
 <p>Low</p>	<p>When the power key is turned on, in normal airflow mode (intelligent sense constant suction icon is off):</p> <ol style="list-style-type: none"> ① Press the low key, the low icon lights up, the fan starts to work in low. At this time, the display shows "3"; ② Press the low key again, the fan stops working and the low icon goes out.
 <p>Intelligent Sense Constant Suction</p>	<p>After the power key is turned on, press the intelligent sense constant suction key to switch between normal airflow mode and intelligent sense constant suction mode.</p> <p>When the power key is turned on, the intelligent sense constant suction mode is on (intelligent sense constant suction icon is lit):</p> <ol style="list-style-type: none"> ① Press the low key, the low icon will light up, and the fan will start to work in the low of intelligent sense constant suction. At this time, the range hood will automatically control the air volume according to the size of the flue resistance, and at the same time the display shows "3", "2" or "1"; ② Press the low key again, the fan stops working and the low icon goes out. <p>When the power key is turned on, the intelligent sense constant suction mode is on (intelligent sense constant suction icon is lit):</p> <ol style="list-style-type: none"> ① Press the high/turbo key, the high/turbo icon will light up, and the hood will enter the operation state of intelligent sense constant suction high. At this time, the range hood will automatically control the air volume according to the size of the flue resistance, and at the same time the display shows "6", "5" or "4"; ② Press the high/turbo key again, the high/turbo icon will flash, and the fan will start to work in the turbo mode of intelligent sense constant suction. At this time, the range hood will automatically control the size of the wind volume according to the size of the flue resistance, while the display shows "9", "8" or "7"; nearly 3 minutes after the automatic switch to the intelligent sense constant suction after nearly 3 minutes, it automatically switches to the intelligent sense constant suction high operation state; ③ Press this key repeatedly to cycle the fan between "intelligent sense constant suction high - intelligent sense constant suction turbo ".
 <p>Lighting</p>	<p>In the on or off state, follow the bright key to turn the light on or off.</p> <p>Note: When the power is off, press and hold the bright key to cycle between warm light mode and cool light mode.</p>

 <p>AI Smart Control</p>	<p>① Hovering switch function: hovering in front of the induction area can control the switch and synchronize the switching of lighting.</p> <p>② Waving hand to control the air volume function: in the boot state, from left to right waving hand to control the high and burst switching, from right to left waving hand to control the low and off switching.</p> <p>Note: Shutdown state at the same time long press the high/turbo key and low key, you can turn off or turn on the AI smart control function; at the same time long press the high/turbo key and the lighting key, you can turn off or turn on the synchronized switch lighting function.</p>
 <p>Cleaning Reminder</p>	<p>The cleaning reminder icon flashes to remind the user to clean the filter when the hood has run for a total of 60 hours, at which point:</p> <p>① Long press the cleaning reminder key, the cleaning reminder icon will light up, and enter the cleaning mode (the fan stops, the lighting and the wind guide plate open, except the cleaning reminder key and the lighting key, the rest of the keys are invalid). Users have to clean the filter by themselves, after cleaning, long press this key to exit the cleaning mode, the accumulated time is cleared to zero.</p> <p>② If the user does not clean in the cleaning reminder state, the icon will keep flashing to remind the user to clean.</p> <p>You can also long press the cleaning reminder key to enter the cleaning mode if the hood has not reached 60 hours of cumulative operation.</p>

Maintenance

Notice

- The hood shall be cleaned and maintained regularly depending on the surroundings, so as to keep its cleanness & efficiency and extend its service life.

We recommend that: Clean the outer surface of range hood after each cooking.

To ensure smooth discharge of fumes, the protective screening shall be cleaned regularly according to actual situations. Be careful to avoid damage when cleaning.

- It is recommended to use a neutral detergent to clean instead of strong detergents, and dry with a soft cloth. If your range hood is a mechanical switch, you should also avoid detergent touching each control key.
- Do not allow stains to stay on the surface of the hood for too long.
- Please do not use cleaning balls, brushes and other rough objects to clean the hood to prevent the body surface from scratching.
- When cleaning or maintaining the hood, please wear protective gloves to prevent wounding during wiping.
- Please check and clean the oil cup regularly by squeezing the cup with both hands as shown on the right and pulling it outward to pour off the waste oil.
- The range hood shall be started before cooking.
- Please unplug it during long-term shutdown, but please do not pull hard.



Removal of Components

Note: The installation procedures of the following components are in reverse with the removal. Please wear protective gloves during operation to prevent the sharp edge of metal hurting your hands.

⚠ The disassembly must be carried out by professional personnel, and users are not allowed to carry out the disassembly. Before installation or disassembly, the power supply must be cut off to avoid electric shock.

Removal of lamp

- Long press the low key + lighting key to make the air guide open, and then unplug the power supply.
- Insert a screwdriver or a flat metal object into the gap along the edge of the LED light, force it to warp outward, remove the LED light and unplug the connecting wire, then you can repair and replace it.

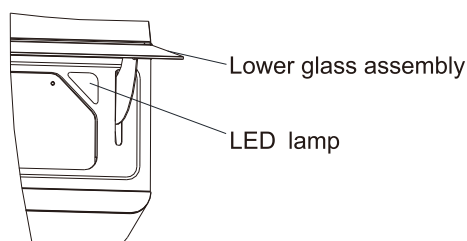

Lamp image		Lamp information	
		Lamp Type	Triangles LED
		Max Power	2W×2
		Voltage	12VDC
		Dimension	See the lamp image

Removal of switch

- Unscrew the two screws on the top of the hood with a screwdriver, move the upper glass assembly to the left, and then remove the upper glass assembly outward when it is in place. Unplug the connecting wires for repair and replacement.

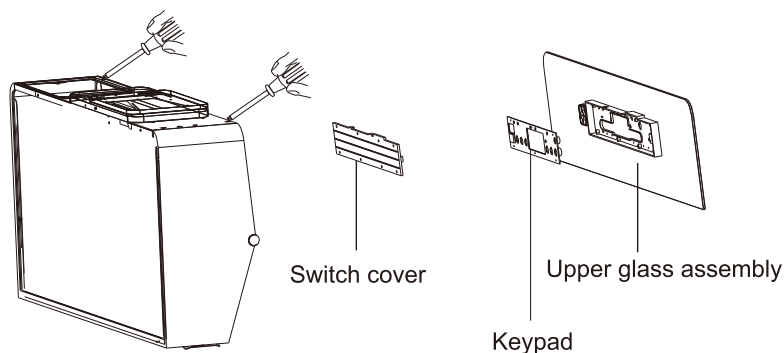

Removal of filter

- Long press the low key + lighting key to make the air guide open, and then unplug the power supply.
- Remove the screws on the left and right sides of the filter by turning 90° counterclockwise with a screwdriver against the screw holes.
- Insert your fingers into the center filter hand hole, hold the filter and lift it upward, so that the lower end of the filter is out of the slot to remove the filter.

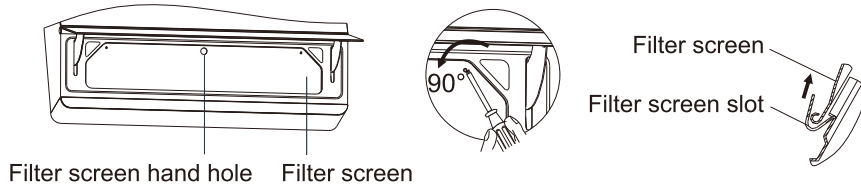

Remove the whole range hood

1. Remove the LED lamp and filter according to the steps of "Removal of lamp " and "Removal of filter" respectively;
2. Unplug the power supply, remove the oil cup and take off the whole machine;
3. Remove the switch assembly by following the steps in Switch Disassembly;
4. Unscrew the screws on the rear plate and remove the rear plate;
5. Unscrew the screws on the duct assembly and remove the duct assembly;
6. Unscrew the retaining ring and fairing screen screws to remove them, and at the same time turn down the cap clockwise to remove the impeller vertically.

The assembly procedure is the reverse of the disassembly procedure.

(When putting on the impeller, please put some lubricant in the shaft hole of the impeller.)

Note: Remove the mainframe panel and mainframe accessory panel, if any, first.

 The body does not need to be disassembled under normal circumstances. Disassembly is to be done by specialized maintenance personnel.

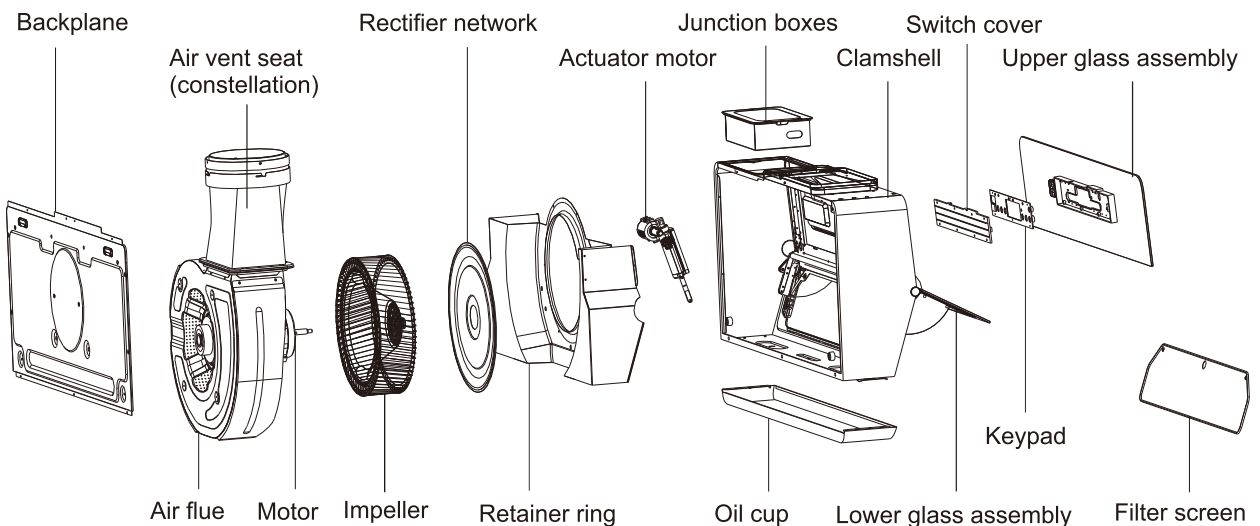

Circuit Diagram

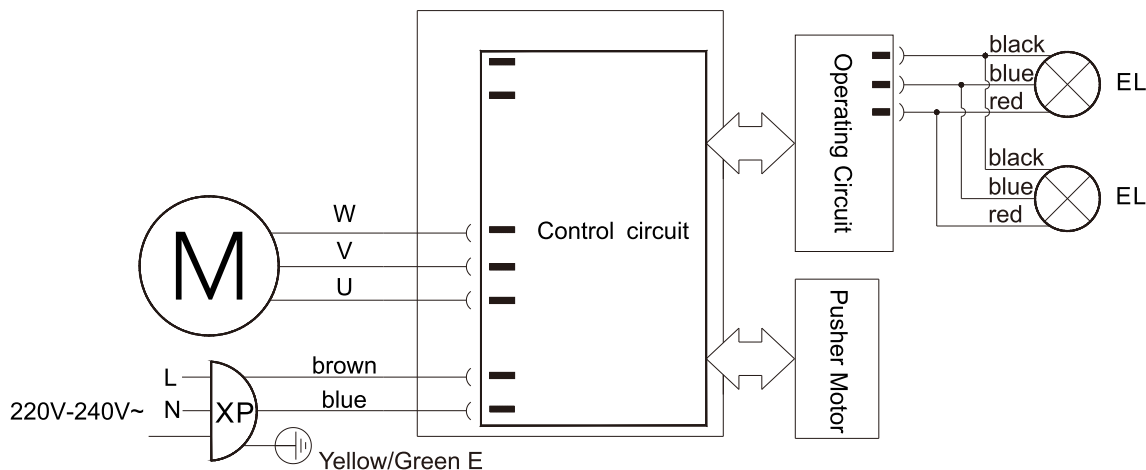

Troubleshooting of General faults

Serial number	Fault	Cause	Solution
1	No response after pressing any icon (e. g. the impeller does not rotate, or the light is off)	The power plug is not connected properly or there is power failure	Plug in the power plug
2	Pressing the lighting icon, the headlamp is not lit	The light is damaged or poorly connected	Replace the light or plug in the plug
3	Induced current exists on the hood body may paralyze hands	The power socket is not grounded well	Use single-phase three-pole socket and well grounded
4	Abnormal sound during impeller running	The impeller is loose, and the cap is not tightened	Tighten the cap
5	No oil in the oil cup after a period of time	The hood body is tilt	Adjust the hood body to the horizontal state
6	Open the air guide in the process of hearing a few beeps prompt, or the air guide can not open completely	Electric actuator drive circuit failure, or electric actuator failure, or electric actuator wire poor contact	Contact a repair professional
 Warning	1. When connecting or replacing the plug, please unplug the power plug. 2. If the range hood's power cords are damaged, it must be replaced by our company's professional maintenance staff.		

Edition: A/0

Publication Date: January, 10, 2024

ROBAM