

ROBAM



User Manual

Before operating this unit, please read the user manual completely and keep it. If the manual is lost, you can send e-mail to overseas@robam.com, request for an electronic manual.

CXW-260-76H1S

Range Hood

CONTENTS

Safety Precaution.....	1
Important Information.....	4
Product Description.....	5
Packing List.....	5
Installation.....	6
User Manual.....	10
Maintenance.....	11
Removal of Components.....	12
Circuit Diagram.....	14
Troubleshooting of General faults.....	14

Dear users:



Thank for your buying our range hood. Please accept our best regards. Please read this user manual carefully before installation and operation.

*The pictures in this manual only for your reference. If the picture isn't accord with object, subject to object. We keep to right to update appearance, structure or products without notice.

Safety Precaution

In order to avoid harm or property damage to the users or other person, the following distinction and marks are stipulated. They are important safety precaution, please comply strictly based on the full understanding.

Subject to harmful or destruct degree







 Danger	If ignore this sign and operate product improperly, it's highly possible to cause danger, serious injury or fire.
 Warning	If ignore this sign and operate product improperly, it's possible to cause danger, serious injury or fire.
 Notice	If ignore this sign and operate product improperly, it's possible to cause injury or loss.

Notice and Prohibit Mark

 Prohibit	 Prohibit Flame	 Prohibit Touch	 Prohibit Touch by Wet Hand	 Prohibit Disassembly	 Strict Execution	 Necessary Earthed	 Caution Electric Shock	 Caution Scald
---	--	--	--	--	--	--	--	---

 Warning Please use this product according to manual strictly, or ROBAM shall not take any responsible caused by improper operation.

Danger

 Prohibit	Don't allow children or weakling to use range hood separately, or it may cause electric shock or other accident.
 Prohibit	Prohibit water on motor, switches or other electric parts; Prohibit wash range hood by water spray. Don't use range hood if wet or it may cause electric leakage or shock.
 Prohibit	Don't change, stretch, bind or press electric wire, or it's possible to cause electric shock or fire because of broken wire.
 Prohibit	Prohibit any change of interior circuit, or it may cause injury or other danger, for example, electric shock or fire.
 Prohibit Touch by Wet Hand	Don't touch plug, electric parts or button by wet hands, or it may cause electric shock.
 Strict Execution	Unplug before cleaning, installing or maintaining, avoiding from electric shock.

Danger

Strict
Execution

Please turn off range hood immediately if pan got fire (range hood shall aggravate fire if it's working) and extinguish fire by effective action. For example, cover flame by metal cover, turn off gas valve immediately and remove inflammable things.

Strict
Execution

Any abnormal, please turn off power, take off plug or cut off electric source, and contact service. It's possible to cause electric shock or fire if using range hood under abnormal situation.

Warning

Prohibit
Disassembly

Range hood must be installed, disassembled or maintained by professional person.

Prohibit

Stove fire shall be extinguished timely when it is not used; do not flambe under the range hood and it's prohibited to bake food under range hood directly to prevent range hood from damaging and causing accidents.

Prohibit Touch

Don't touch bulb if it's on or just close in short time, or it may cause scald.

Strict
Execution

In order to ensure safety, range hood must be installed by specific accessory (especially expansion pipe and wooden screws, or it may cause accidental drop of range hood). The pipe bore and hole must fit tightly during the installation of metal expansion pipe. It is prohibited to make excessively large hole to prevent accidental drop of loosening expansion pipe.

Strict
Execution

The range hood must be used by specific plug and properly ground it. It's possible to cause electric shock, hot plug or fire because of improper electric wire. Installation must be executed by professional person based on local electrical regulations. Before connect electricity, power must be turned off.

Strict
Execution

If the supply cord is damaged, it must be replaced by the manufacturer, its service agent or similarly qualified persons in order to avoid a hazard.

Strict
Execution

All operation must comply with our safety guidelines as well as local safety regulations.









Strict
Execution

There shall be adequate ventilation of the room when the range hood is used at the same time as appliances burning gas or other fuels.



Strict
Execution

This appliance just for household use only. And it's not allowed to exhaust dangerous or explosive matter or air. It should be put under dry and ventilation environment without dangerous air.







Warning

 Strict Execution	The range hood and electric circuit must be installed by skilled and trained personnel with required qualification. When installation, the related regulation, standard or instruction on fire must be complied. It may cause danger because of improper installation, for example, electric shock, drop or fire accident.
 Strict Execution	The outlet must be connect with outside. In order to ensure safety and fresh air, waste gas should be exhaust to outside. Don't exhaust waste gas to the wall, loft or garage.
 Strict Execution	There is a fire risk if cleaning is not carried out in accordance with the instructions.
 Strict Execution	Keep a good habit to turn off gas hob and gas valve if go outside, sleep or finish operation. Replace or check gas pipe regularly, since gas alarm device can't completely avoid accident caused by gas leakage.
 Strict Execution	This appliance is not intended for use by persons (including children) with reduced physical, sensory or mental capabilities, or lack of experience and knowledge, unless they have been given supervision or instruction concerning use of the appliance by a person responsible for their safety. Children should be supervised to ensure that they do not play with the appliance.
 Strict Execution	The minimum distance between the supporting surface for the cooking vessels on the hob and the lowest part of the range hood. When the range hood is located above a gas appliance, this distance shall be at least 650mm. If the instructions for installation for the gas hob specify a greater distance, this has to be taken into account.
 Strict Execution	Range hoods and other cooking fume extractors may adversely affect the safe operation of appliances burning gas or other fuels (including those in other rooms) due to back flow of combustion gases. These gases can potentially result in carbon monoxide poisoning. After installation of a range hood or other cooking fume extractor, the operation of flued gas appliances should be tested by a competent person to ensure that back flow of combustion gases does not occur.

Notice

 Prohibit	The air must not be discharged into a flue that is used for exhausting fumes from appliances burning gas or other fuels, the discharge of air must fulfill the requirements of local regulations.
 Strict Execution	Before removing range hood for installation, clean or maintainance, power must be cut off avoiding from electric shock. When installation, clean or maintainance, protective gloove must wear avoiding from injury.

Notice

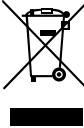
 Strict Execution	<p>The temperature for range hood working can't exceed 40°C.</p>
 Strict Execution	<p>Because the installation is difficult and hood is heavy, the installation shall be executed by professional person based on manual.</p>
 Strict Execution	<p>Don't break electric wire or other invisible equipment when cutting something or drilling holes on ceiling.</p>
 Strict Execution	<p>When range hood is using in well sealed building, it should have air inlet or open door to ensure good ventilation.</p>
 Strict Execution	<p>When the oil exceeds 2/3 or near tick mark in the oil cup, clean it in time. Don't eat waste oil from oil cup.</p>
 Strict Execution	<p>The wall of installing range hood needs enough strength. For hollow walls, the thickness of solid layer of hollow wall must be more than 30mm, but for concrete walls, it can be drill holes directly. The range hood must be fixed on the wall firmly.</p>
 Strict Execution	<p>CAUTION: Accessible parts may become hot when used with cooking appliances.</p>
	<p>DISPOSAL: Do not dispose this product as unsorted municipal waste. Collection of such waste separately for special treatment is necessary. This product must not be disposed together with the domestic waste. This product has to be disposed at an authorized place for recycling of electrical and electronic appliances. By collecting and recycling waste, you help save natural resources, and make sure the product is disposed in an environmental friendly and healthy way.</p>

Important Information

Package of Range Hood

Please settle those packages carefully in order to protect environment. Don't allow children to play plastic film and package, it may cause asphyxia. Please avoid children near package material.

Before use Range Hood

This range hood exhaust fume outside. Please read this manual and all information carefully before installation and operation. Please comply with our suggestion. If it's necessary, please read manual for gas hob. And please keep these manual carefully for future reference. If range hood has obvious damage, please don't electrify and contact operator. This manual is available for different models. So you may find different description with your own range hood.

Product Description

Technical Data

Model	CXW-260-76H1S		Noise	Low	44dB (A)
Rated Voltage	220-240V~			High	54dB (A)
Rated Frequency	50Hz		Rated Power Input		264W
Nominal Wind Pressure	500Pa		Rated Main Motor Power Input		260W
Airflow	High	1080m ³ /h	Lamp Power(max)		2W×2
	Turbo	1380m ³ /h	Dimension (L×W×H)		(795×204×457)mm
Max static pressure	950Pa		Net Weight		22kg

Note: 1. The performance test results are all in 230V~50Hz power supply environment. The noise is according to IEC 60704.
 2. The determined value of nominal wind pressure,max static pressure shall not be less than 90% of declared value.
 3. The noise declared value shown is A weighted sound pressure level.

Body Size

The marked sizes are for reference only, the depth dimension includes machine feet. (Unit: mm)

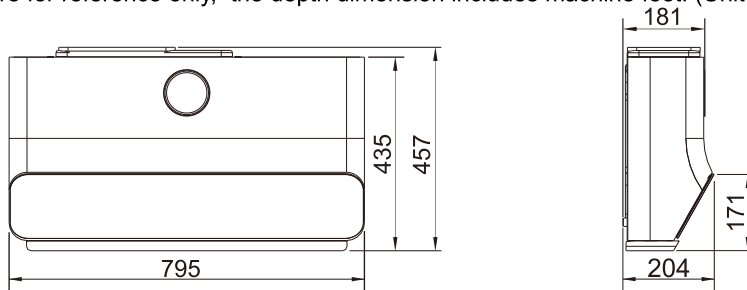

Packing List

Please check the items in the container upon unpacking

Packing List	No.	Name	Quantity	No.	Name	Quantity
	1	Range hood	1	8	ST4.2×18 self-tapping screw	6
	2	∅185(outer diameter) aluminum exhaust pipe	1	9	ST4.2×8 self-tapping screw	6
	3	Plastic expansion pipe	4	10	4×60 wood screw	4
	4	User manual	1	11	M6 metal expansion pipe	1
	5	Air outlet holder	1	12	Hitching foot stopper	1
	6	Pressing strips	1	13	Hitching foot	2
	7	M4×9 screw	2	14	Oil cup	1

Note: Please put the oil cup in the box on the hood body when using.

Optional Accessories	No.	Name	Quantity	No.	Name	Quantity
	1	Main hood panel component	1	3	Pegboard component	1
	2	Adjustable hook component	1			

Installation

 If the flue aperture is less than air duct aperture, it will influence the fume suction effect and the too long air duct will influence the fume suction effect, too.

Preparation for installation

● Surrounding

Keep the hood away from too many doors and windows, so as to avoid air convection affecting the efficiency.

● Tools preparation

The hood will be installed with the following tools

1.an impact drill (with drill bit); 2.a wrench; 3.a screwdriver; 4.a ruler.

Notice

- Installation and circuit setting must be done by experienced professionals. Only a professionally trained person with an installation qualification can install the hood. Non-professionals are not allowed to install, dismantle and repair the hood.
- Please do not power on the hood before installation to avoid electric shock.
- Do not expose the hood if your kitchen is under renovation, because construction materials, dusts, paint, coatings, and emitted gases will corrode and tarnish the hood surface. Therefore, it is recommended to install it after the renovation is completed.
- If you need move the Gas Hob before installing the Range Hood, please close the main valve before moving the Gas Hob.
- Don't install the hood on wood and other combustible walls. The wall shall be made of noncombustible materials with enough strength and the surface shall be flat.
- The hood may have very sharp edges. So, please wear protective gloves during hood installation, cleaning or repair.
- When drilling on the wall or ceiling board, keep away from embedded wires and other concealed devices to avoid electric shock and fire.
- Do not install the hood at a too high position as well as keep the hood free from disturbance of ambient airflow lest the reduction of smoke pumping effect shall occur.
- When making cabinet, please leave space for installation and disassembly of the hood in order to maintain and overhaul the hood.
- When installing, please keep the machine body remain horizontal.
- Please use single phase grounded socket and the hood shall be well grounded (water pipe grounding is not reliable and gas pipeline grounding has risks of causing fire disaster and explosion).
- In order to ensure safety and successful installation, please use standard accessories provided with the hood for installation, otherwise the hood may be at risk of falling down.
- If the power cord is damaged, in order to avoid danger, it must be replaced by manufacturer, professionals of its maintenance department or similar departments. Please do not carry out restructuring, stretching, knotting and squeezing or apply heavy objects to the power cord, etc., otherwise it may cause power cord damage easily, leading to accidents such as electric shock and fire disaster, etc.
- The installation height of the mounting section is only applicable to electric cookers. The minimum distance between the supporting surface for the cooking vessels on the hob and the lowest part of the range hood. When the range hood is located above a gas appliance, this distance shall be at least 650mm. If the instructions for installation for the gas hob specify a greater distance, this has to be taken into account.
- After installation, please clean the surface of the hood, and then supply power for test run.

Installation

Note: All data in synoptic diagram below are recommended dimensions, and units are expressed in mm.

●Determine the location:

To ensure a good operating experience, it is recommended that the top of the fume hood be flush with the bottom of the hanging cabinet. The following three installation methods are listed below according to the reserved size of the hood, and option a is preferred:

a. Installation method when the width of the hanging cabinet is greater than 800mm (the following installation method takes 900mm as an example)

The cabinet pre-determined size is shown in Figure 1, the cabinet and ceiling opening size is shown in Figure 2 and Figure 3, the socket location is recommended to be installed above the ceiling.

Figure 1

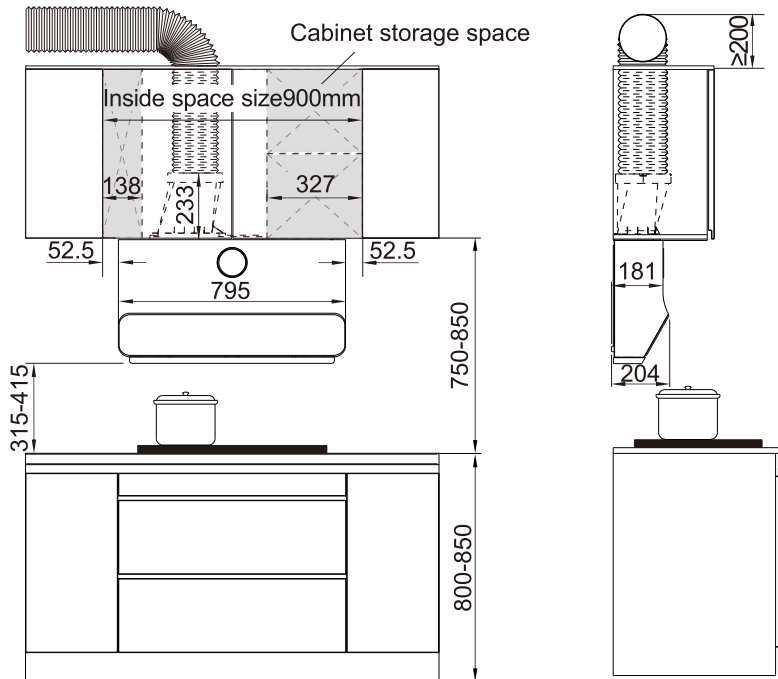
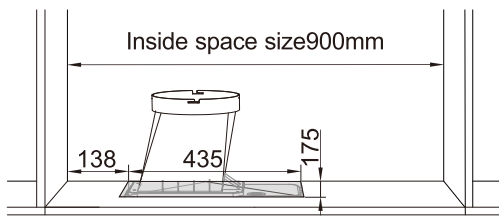
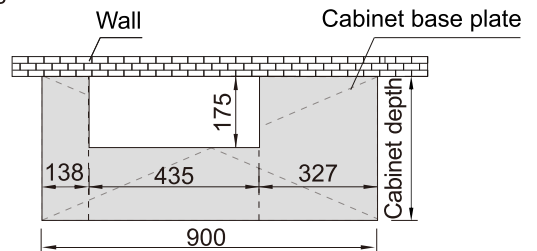

Figure 2-1



Cabinets removable bottom openings dimensional drawing

Figure 2-2



Removable bottom (shaded space for storage) projection dimensional drawing

Figure 3

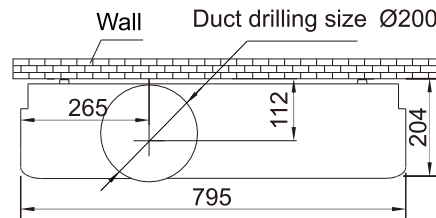

Ceiling hole sizes(Projection size of the hood top)

b. Installation method when there is no hanging cabinet

The size of the cabinet reservation is shown in Figure 4, the size of the ceiling opening is shown in Figure 3, and the socket location is recommended to be installed above the ceiling.

Figure 4

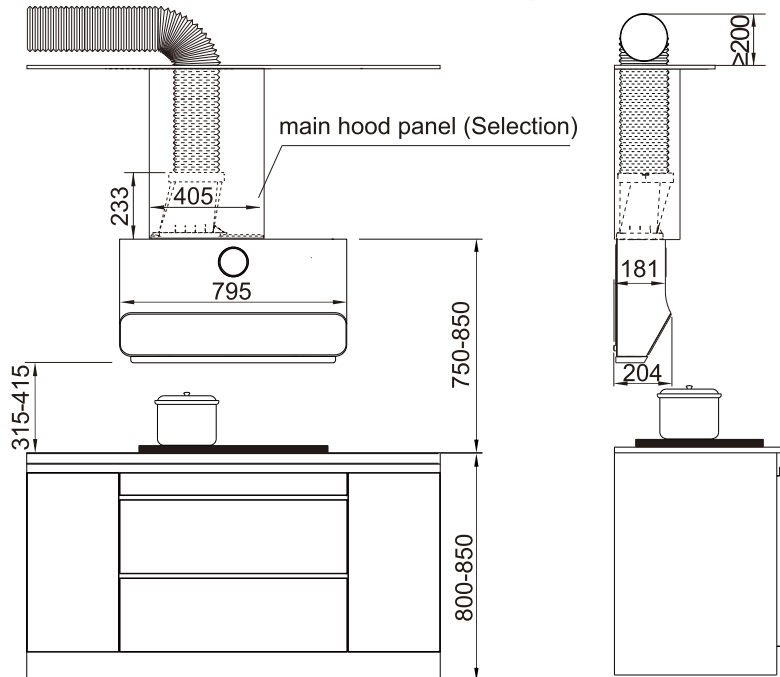

c. Installation method when the hanging cabinet width is 435-800mm (the following installation method takes 450mm as an example)

Cabinet pre-determined size as Figure 5, cabinet and ceiling opening size as Figure 6 and Figure 3, socket location is recommended to be installed above the ceiling.

Note: If this solution is used for installation, users need to purchase special hooks, please contact with the after-sales service center for specific installation.

Figure 5

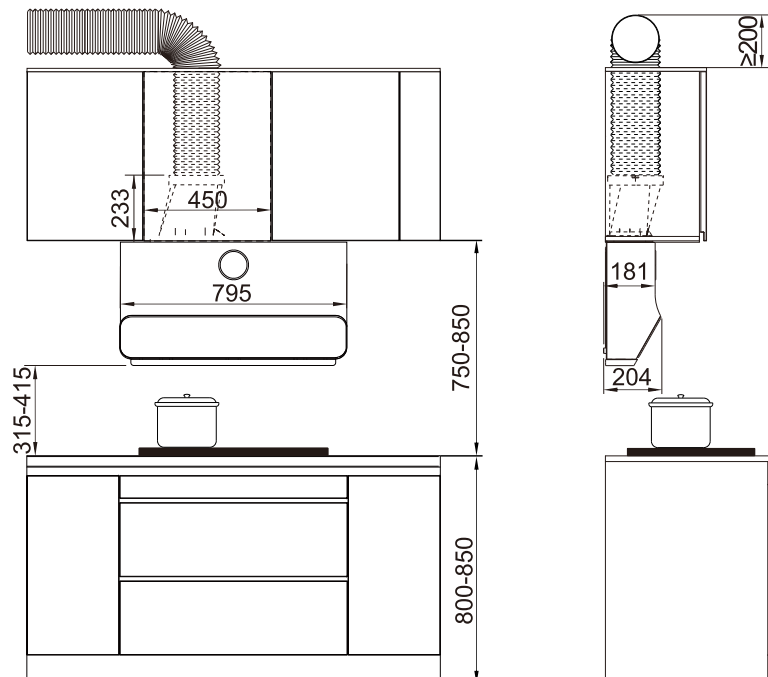
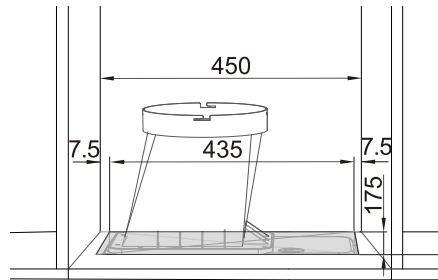

Figure 6



Cabinets removable bottom openings dimensional drawing

● Install hitching feet

According to the size of the hitching feet, drill four 60-70mm-deep holes on the wall accordingly with an 10mm-diameter drill bit (overlarge holes are prohibited). Press the expansion pipe into the holes, and then fix the hitching feet with 4 accompanying 4×60mm wood screws. Drill a hole with diameter of 10mm and depth of 50-55mm at the position 55mm above the four holes and insert the M6 metal expansion pipe into the hole. (Figure 7)

Figure 7

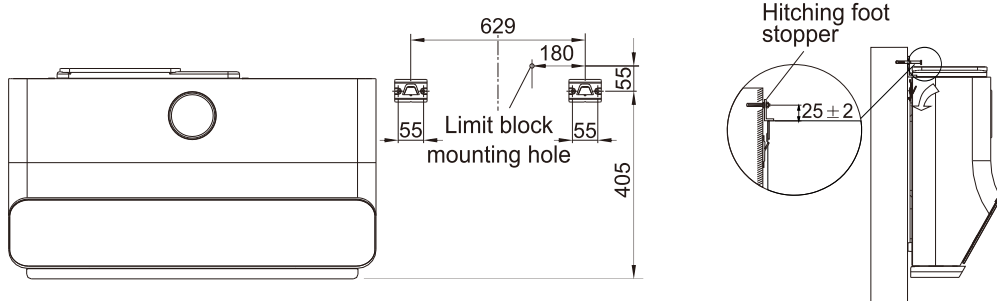

● Install hood body

The air outlet seat is fixed as shown in Figure 9, and the hanging hole at the rear of the hood body is aligned with the hook of the hanging foot as shown in Figure 7, and the hood body is shaken by hand to see if it is hung firmly. After the hood body is installed in place, put in the M6 metal expansion tube to hang the foot limit block, gasket, and tighten the nut (to prevent the hood body from accidentally unhooking under the action of external force).

Connection the aluminum exhaust pipe

● Drilling position of the aluminum exhaust pipe (public flues do not require drilling)

- Aluminum exhaust pipe and hob facing the window: Remove one of the glasses and install a plywood with ventilation holes or punch directly on the glass.
- Hob away from the window: Install the aluminum exhaust pipe through the window that is close to the hob and connected outside; or install it by punching on the wall that is close to the hob and connected outside.
- Drill hole through the wall: Determine the location of the aluminum exhaust pipe against the wall and draw the drilling range (i.e. a circle slightly larger than the pipe OD). Then use a long drill bit to drill through the wall. Pay attention to the wall structure and material, so as not to destroy other parts of the wall.

● Link the aluminum exhaust pipe

First, straighten the aluminum exhaust pipe, put the end without duct fixing strip on the public flue interface and tape it (if there is no public flue, please pull the duct directly to the outdoor). When the public flue interface or wall hole is larger than the aluminum exhaust pipe, it can be directly connected, when it is smaller than the duct, you can choose the duct interface. First, put one end of the aluminum exhaust pipe without duct fixing strip on the duct interface with tape, and then connect it with the public flue interface. The small end of the duct connector has five specifications: 140mm, 150mm, 160mm, 170mm, and 180mm outside diameter, and the excess part smaller than the public flue connector or wall hole can be cut off according to the actual situation.

Then, put the four snaps of the air outlet holder interface into the four slots of the air outlet holder and rotate clockwise to fix it. Finally, the end of the aluminum foil duct with the duct fixing strip is inserted into the outer ring of the air outlet seat interface, fixed with three ST4.2×8 screws distributed and sealed with duct tape.

Figure 8

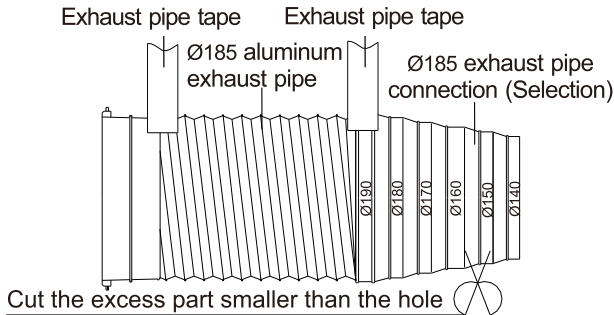

Note: During installation, straighten the aluminum exhaust pipe to avoid noises in semi-stretched state. Excess part may be cut with a wire cutter.

The exhaust wall hole diameter shall be close to that of the exhaust pipe, which shall not be too small. Otherwise, it will cause poor exhaust efficiency, more noises and lower volume, etc. The connection between the pipe and the hole or the public flue must be sealed tightly to ensure that the pipe and the check valve or public flue is connected securely. The blades at the public flue connection must be flexible.

Figure 9

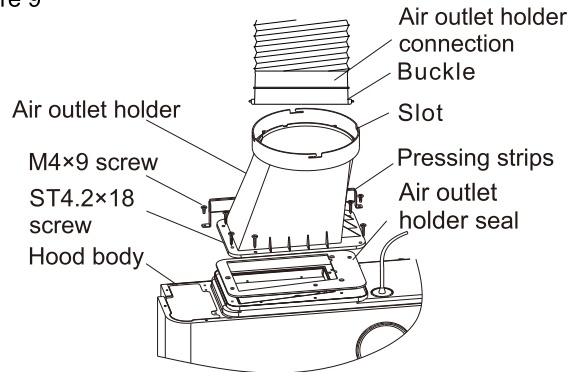



Note: Please install the air outlet seat seal with the adhesive side facing up.



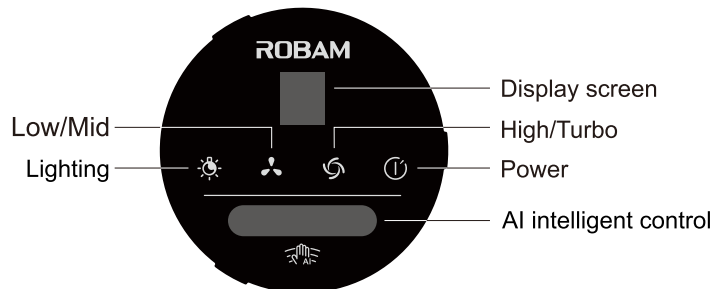

User Manual

Switch control panel



Turn on the power, the buzzer sounds to indicate the power-on state.

 <p>Power</p>	<p>Press the power button to enter the power-on state, and the power button icon lights up for a long time.</p> <p>① In the state of the fan not running, press the power button to enter the shutdown state;</p> <p>② In the fan running state, press the power button, the hood will enter the delayed working state, and automatically turn off all functions after 1 minute; during the delay, the delayed shutdown can be canceled according to the Ming key and gear key</p> <p>③ In the power-on state, if there is no operation within 3 minutes, it will enter the power-off state.</p>
 <p>High/Turbo</p>	<p>In the power-on state :</p> <p>① Press the high/turbo button, the high/turbo icon lights up (the display shows "3") , into the high gear operation state;</p> <p>② Then press the high/turbo button, high/turbo icon flashing (the display shows "6"), the fan starts turbo gear, 3 minutes later automatically switch to high gear, then the icon is long light, into the high gear operation state ;</p> <p>③ Repeatedly press this button, the fan in the "high gear-turbo gear" between the cycle of switching.</p>

 <p>Low/Mid</p>	<p>In the power-on state:</p> <ol style="list-style-type: none"> ① Press the low/mid button, the low/mid icon lights up (the display shows "1") and the fan starts working in the low gear; ② Then press the low/mid button again, the low/mid icon flashes (the display shows "2"), and it enters the medium work; ③ Repeatedly press this button, the fan in the "low gear - mid gear" between the cycle of switching.
 <p>Lighting</p>	<p>Press the bright button to turn the illumination on, and press the bright button again to turn it off. When the power button is off, follow the bright button, then the lighting and the air guide will be opened at the same time.</p> <p>Note: The initial power-up default light mode is cold light. When the power is off, long press the bright button to cycle between warm light mode and cool light mode.</p>
 <p>AI intelligent control</p>	<ol style="list-style-type: none"> ① Hover in front of the detection area can control the switch on and off and synchronize the light switch, waving from left to right to control the large air volume burst and strong gear switch, waving from right to left to control the small air volume weak gear and off switch; ② Off state while long press the high/turbo button + low/mid button, you can turn off or on the detection function, while long press the high/turbo button + lighting button, you can turn off or on the gesture on the automatic light function.
 <p>Cleaning lock</p>	<p>In the off state, press and hold the low/mid button + lighting key at the same time to enter the cleaning lock state, low/mid, lighting key icon long light, air guide, lighting automatically open, fan off. In this case, all keys are invalid except for the following keys.</p> <ol style="list-style-type: none"> ① according to the bright key, lighting off, low/mid and lighting icon slow flash, again according to the bright key, lighting on, low/mid and lighting icon long light, and so on cycle; ② simultaneously long press the low/mid button + lighting button to exit the cleaning lock state, enter the shutdown state, the air guide and lighting off.

Maintenance

Notice

- The hood shall be cleaned and maintained regularly depending on the surroundings, so as to keep its cleanness & efficiency and extend its service life.
We recommend that: Clean the outer surface of range hood after each cooking.
To ensure smooth discharge of fumes, the protective screening shall be cleaned regularly according to actual situations. Be careful to avoid damage when cleaning.
- It is recommended to use a neutral detergent to clean instead of strong detergents, and dry with a soft cloth. If your range hood is a mechanical switch, you should also avoid detergent touching each control key.
- Do not allow stains to stay on the surface of the hood for too long.
- Please do not use cleaning balls, brushes and other rough objects to clean the hood to prevent the hood body surface from scratching.
- When cleaning or maintaining the hood, please wear protective gloves to prevent wounding during wiping.
- Please regularly check and clean the oil cup. As shown in the right figure, hold the oil cup with both hands, pull it out and pour out the waste oil.
- The range hood shall be started before cooking.
- Please unplug it during long-term shutdown, but please do not pull hard.



Removal of Components

Note: The installation procedures of the following components are in reverse with the removal. Please wear protective gloves during operation to prevent the sharp edge of metal hurting your hands.

⚠ Disassembly must be carried out by professionals, and users are not allowed to carry out disassembly. Unplug before installing or disassembling, avoiding from electric shock.

Removal of lamp

- Long press the low/mid button + lighting button to make the air guide open, then unplug the power supply.
- Use a screwdriver or a flat metal object to insert into the slit of the edge of the LED lamp, force outward, remove the LED lamp and unplug the connecting wire, you can repair and replace.

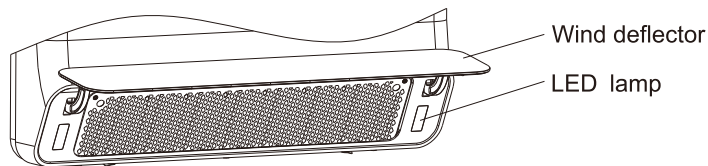

Lamp image		Lamp information	
		Lamp Type	Rectangular LED
		Max Power	2W
		Voltage	12VDC
		Dimension	See the lamp image

Removal of switch

- Use suction cups to suck the middle of the switch assembly, pull it out vertically, and unplug the connecting wires for repair and replacement.

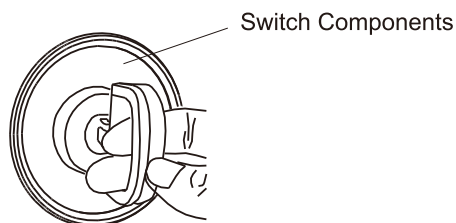

Removal of filter

- Long press the low/mid button + lighting button to make the air guide open, then unplug the power supply.
- Remove the screws on the left and right sides of the screen by rotating 90° counterclockwise with a screwdriver against the screw holes.
- Put your fingers into the filter hand holes on both sides, hold the filter and lift it upwards, so that the lower end of the filter can be removed from the slot.

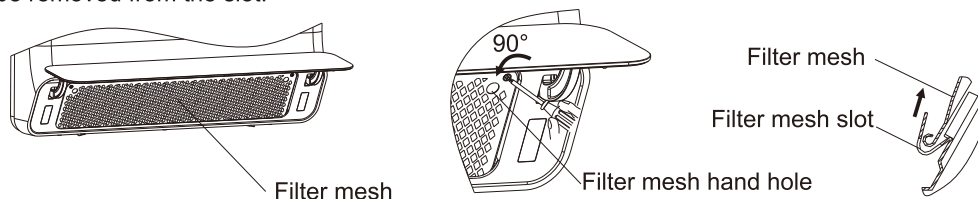

Removal of the hole range hood

1. Remove the LED lamp and filter according to the steps of "Removal of lamp" and "Removal of filter", respectively.
2. Unplug the power supply, remove the oil cup and take off the whole machine.
3. Remove the switch assembly according to the steps in "Removal of Switch".
4. Remove the screws on the rear panel and remove the rear panel and power board.
5. Remove the air duct assembly by unscrewing the screws on the air duct assembly.
6. Unscrew the retaining ring and rectifier mesh screws to remove them, while screwing down the cap clockwise to remove the impeller vertically.

The installation procedure is the reverse of the disassembly procedure. (When putting on the impeller, please put some lubricant in the shaft hole of the impeller)

Note: If there is a host panel and host attached panel installed then remove them first.

 In general, the range hood body does not need to remove. The removal needs to be completed by professional maintenance staff.

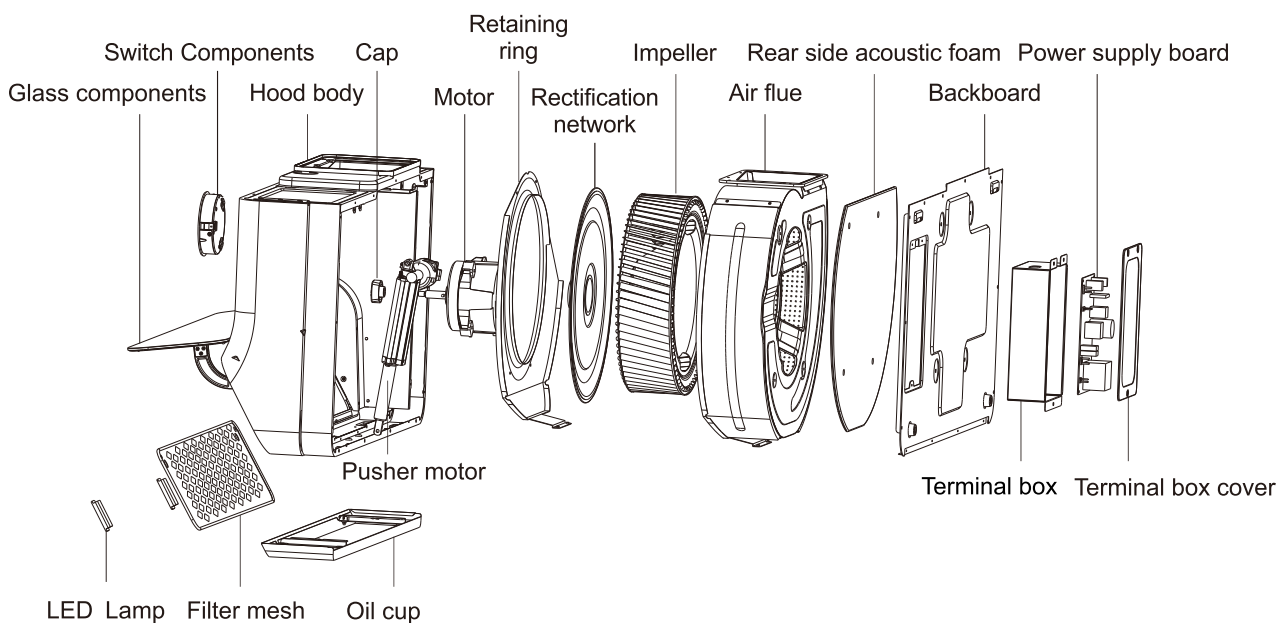

Circuit Diagram

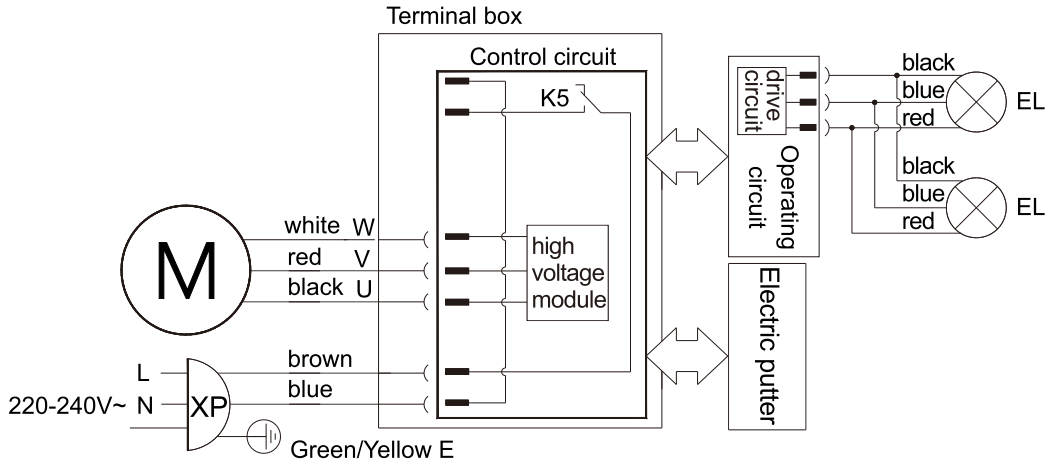

Troubleshooting of General faults

Serial number	Fault	Cause	Solution
1	No response after pressing any icon (e. g. the impeller does not rotate, or the light is off)	The power plug is not connected properly or there is power failure	Plug in the power plug
2	Pressing the lighting icon, the headlamp is not lit	The light is damaged or poorly connected	Replace the light or plug in the plug
3	Induced current exists on the hood body may paralyze hands	The power socket is not grounded well	Use single-phase three-pole socket and well grounded
4	Abnormal sound during impeller running	The impeller is loose, and the cap is not tightened	Tighten the cap
5	No oil in the oil cup after a period of time	The hood body is tilt	Adjust the hood body to the horizontal state
6	Open the air guide in the process of hearing a few beeps prompt, or the air guide can not open completely	Electric actuator drive circuit failure, or electric actuator failure, or electric actuator wire poor contact	Contact a repair professional
 Warning	1. When connecting or replacing the plug, please unplug the power plug. 2. If the range hood's power cords are damaged, it must be replaced by our company's professional maintenance staff.		

Edition: A/0

Publication Date: October, 25, 2022

ROBAM