

ROBAM

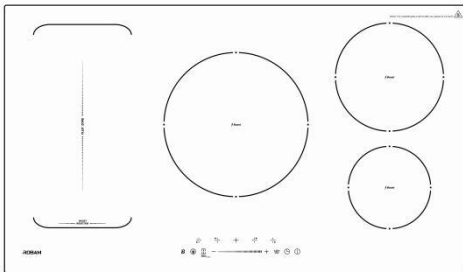

User Manual

Before operating this unit, please read the user manual completely and keep it. If the manual is lost, you can send e-mail to overseas@robam.com, request for an electronic manual.

CD72-9W9H50
INDUCTION COOKTOP

Contents

Safety Warnings.....	3
Technical Specification.....	8
Product Overview and Parameters.....	9
How to choose right cookware.....	11
Use Instruction.....	12
Cooking Guidelines.....	23
Care and Cleaning.....	25
Troubleshooting.....	28
Installation instruction.....	29

Dear Users,

Let us take this opportunity to thank you for your purchase of ROBAM induction hob. We recommend that before the installation and use. Please read this manual and save it for your future reference. ROBAM is a professional enterprise in China's household appliances and kitchenware. It's famous with advanced design, high efficiency, saving energy and safety.

Safety Warnings

Your safety is important to us. Please read this information before using your cooktop.

Installation

Electrical Shock Hazard

- Disconnect the appliance from the mains electricity supply before carrying out any work or maintenance on it.
- Connection to a good earth wiring system is essential and mandatory.
- Alterations to the domestic wiring system must only be made by a qualified electrician.
- Failure to follow this advice may result in electrical shock or death.

Cut Hazard

- Take care - panel edges are sharp.
- Failure to use caution could result in injury or cuts.

Important safety instructions

- Read these instructions carefully before installing or using this appliance.

- No combustible material or products should be placed on this appliance at any time.
- Please make this information available to the person responsible for installing the appliance as it could reduce your installation costs.
- In order to avoid a hazard, this appliance must be installed according to these instructions for installation.
- This appliance is to be properly installed and earthed only by a suitably qualified person.
- This appliance should be connected to a circuit which incorporates an isolating switch providing full disconnection from the power supply.
- Failure to install the appliance correctly could invalidate any warranty or liability claims.

Operation and maintenance Electrical Shock Hazard

- Do not cook on a broken or cracked cooktop. If the cooktop surface should break or crack, switch the appliance off immediately at the mains power supply (wall switch) and contact a qualified technician.
- Switch the cooktop off at the wall before cleaning or maintenance.
- Failure to follow this advice may result in electrical shock or death.

Health Hazard

- This appliance complies with electromagnetic safety standards.
- However, persons with cardiac pacemakers or other electrical implants (such as insulin pumps) must consult with their doctor or implant manufacturer before using this appliance to make sure that their implants will not be affected by the electromagnetic field.
- Failure to follow this advice may result in death.

Hot Surface Hazard

- During use, accessible parts of this appliance will become hot enough to cause burns.

- Do not let your body, clothing or any item other than suitable cookware contact the Induction glass until the surface is cool.
- Metallic objects such as knives, forks, spoons and lids should not be placed on the hob surface since they can get hot.
- Keep children away.
- Handles of saucepans may be hot to touch. Check saucepan handles do not overhang other cooking zones that are on. Keep handles out of reach of children.
- Failure to follow this advice could result in burns and scalds.

Cut Hazard

- The razor-sharp blade of a cooktop scraper is exposed when the safety cover is retracted. Use with extreme care and always store safely and out of reach of children.
- Failure to use caution could result in injury or cuts.

Important safety instructions

- Never leave the appliance unattended when in use.
- Boil over causes smoking and greasy spillovers that may ignite.
- Never use your appliance as a work or storage surface.
 - Never leave any objects or utensils on the appliance.
 - Do not place or leave any magnetisable objects (e.g. credit cards, memory cards) or electronic devices (e.g. computers, MP3 players) near the appliance, as they may be affected by its electromagnetic field.
 - Never use your appliance for warming or heating the room.
 - After use, always turn off the cooking zones and the cooktop as described in this manual (i.e. by using the touch controls). Do not rely on the pan detection feature to turn off the cooking zones when you remove the pans.
 - Do not allow children to play with the appliance or sit, stand, or climb on it.

- Do not store items of interest to children in cabinets above the appliance. Children climbing on the cooktop could be seriously injured.
- Do not leave children alone or unattended in the area where the appliance is in use.
- Children or persons with a disability which limits their ability to use the appliance should have a responsible and competent person to instruct them in its use. The instructor should be satisfied that they can use the appliance without danger to themselves or their surroundings.
- Do not repair or replace any part of the appliance unless specifically recommended in the manual. All other servicing should be done by a qualified technician.
- Do not use a steam cleaner to clean your cooktop.
- Do not place or drop heavy objects on your cooktop.
- Do not stand on your cooktop.
- Do not use pans with jagged edges or drag pans across the Induction glass surface as this can scratch the glass.
- Do not use scourers or any other harsh abrasive cleaning agents to clean your cooktop, as these can scratch the Induction glass.
- If the supply cord is damaged, it must be replaced by the manufacturer, its service agent or similarly qualified persons in order to avoid a hazard.
- This appliance is intended to be used in household and similar applications such as: staff kitchen areas in shops, offices and other working environments; -farm houses; -by clients in hotels, motels and other residential type environments; -bed and breakfast type environments.
- **WARNING:** The appliance and its accessible parts become hot during use.
- Care should be taken to avoid touching heating elements.
- Children less than 8 years of age shall be kept away unless continuously supervised.

This appliance can be used by children aged from 8 years and above and persons with reduced physical, sensory or mental capabilities or lack of experience and knowledge if they have been given supervision or instruction concerning use of the appliance in a safe way and understand the hazards involved.

- Children shall not play with the appliance. Cleaning and user maintenance shall not be made by children without supervision.
- **WARNING:** Unattended cooking on a hob with fat or oil can be dangerous and may result in fire. NEVER try to extinguish a fire with water, but switch off the appliance and then cover flame e.g. with a lid or a fire blanket.
- **WARNING:** Danger of fire: do not store items on the cooking surfaces.
- **Warning:** If the surface is cracked, switch off the appliance to avoid the possibility of electric shock, for hob surfaces of glass-ceramic or similar material which protect live parts
- A steam cleaner is not to be used.
- The appliance is not intended to be operated by means of an external timer or separate remote-control system.
- **CAUTION:** The cooking process has to be supervised. A short term cooking process has to be supervised continuously.
- **WARNING:** In order to prevent tipping of the appliance, this stabilizing means must be installed. Refer to the instructions for installation. **WARNING:** Use only hob guards designed by the manufacturer of the cooking appliance or indicated by the manufacture of the appliance in the instruction for use as suitable or hob guards incorporated in the appliance. The use of inappropriate guards can cause accidents.
- This appliance incorporates an earth connection for functional purposes only.

Congratulations on the purchase of your new Induction Hob.

We recommend that you spend some time to read this Instruction / Installation Manual in order to fully understand how to install correctly and operate it.

For installation, please read the installation section.

Read all the safety instructions carefully before use and keep this Instruction / Installation Manual for future reference.

Technical Specification

Cooking Hob	CD72-9W9H50
Cooking Zones	5 Zones
Supply Voltage	220-240V~
Installed Electric Power	6800 - 7400W
Product Size L×W×H(mm)	900X520X60
Building-in Dimensions A×B (mm)	870 X 490

Weight and Dimensions are approximate. Because we continually strive to improve our products we may change specifications and designs without prior notice.

Product Overview and Parameters

Top View

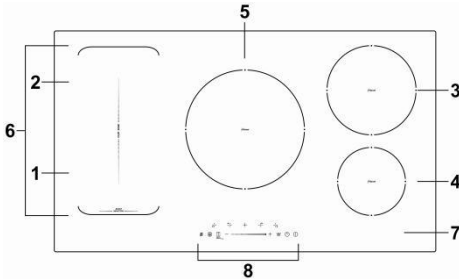

- 1. 2000W Boost 2600W zone
- 2. 1500W Boost 2000W zone
- 3. 2000W Boost 2600W zone
- 4. 1500W Boost 1800W zone
- 5. 2300W Boost 3000W zone
- 6. 2800W Boost 3500W zone
- 7. Glass plate
- 8. Control panel

Control Panel

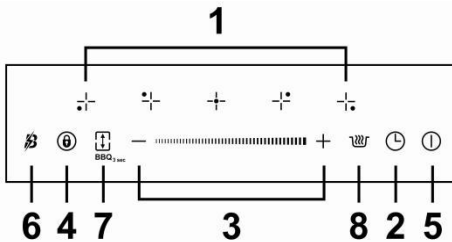

- 1. Heating zone selection controls
- 2. Timer control
- 3. Power / Timer regulating key
- 4. Child lock control
- 5. ON/OFF control
- 6. Boost function control
- 7. Flex zone/BBQ function control
- 8. Keep warm function control

A Word on Induction Cooking

Induction cooking is a safe, advanced, efficient, and economical cooking technology. It works by electromagnetic vibrations generating heat directly in the pan, rather than indirectly through heating the glass surface. The glass becomes hot only because the pan eventually warms it up.

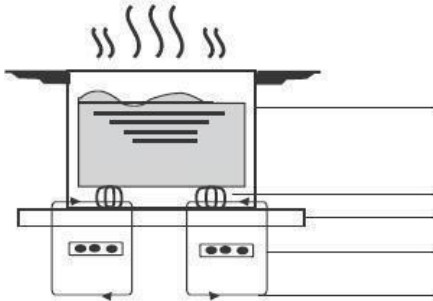

- iron pot
- magnetic circuit
- ceramic glass plate
- induction coil
- induced currents

Before using your New Induction Hob

- Read this guide, taking special note of the 'Safety Warnings' section.
- Remove any protective film that may still be on your Induction hob.

Using the Touch Controls

- The controls respond to touch, so you don't need to apply any pressure.
- Use the ball of your finger, not its tip.
- You will hear a beep each time a touch is registered.
- Make sure the controls are always clean, dry, and that there is no object (e.g. a utensil or a cloth) covering them. Even a thin film of water may make the controls difficult to operate.

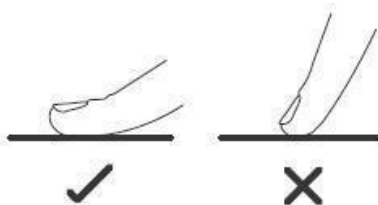

How to choose right cookware



- Only use cookware with a base suitable for induction cooking. Look for the induction symbol on the packaging or on the bottom of the pan.
- You can check whether your cookware is suitable by carrying out a magnet test. Move a magnet towards the base of the pan. If it is attracted, the pan is suitable for induction.
- If you do not have a magnet:
 1. Put some water in the pan you want to check.
 2. If  does not flash in the display and the water is heating, the pan is suitable.
- Cookware made from the following materials is not suitable: pure stainless steel, aluminium or copper without a magnetic base, glass, wood, porcelain, ceramic, and earthenware.

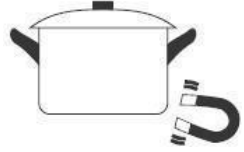

Do not use cookware with jagged edges or a curved base.



Make sure that the base of your pan is smooth, sits flat against the glass, and is the same size as the cooking zone. Use pans whose diameter is as large as the graphic of the zone selected. Using a pot a slightly wider energy will be used at its maximum efficiency. If you use smaller pot efficiency could be less than expected. Pot less than 140 mm could be undetected by the hob. Always centre your pan on the cooking zone.

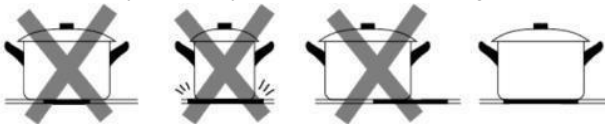

Always lift pans off the Induction hob – do not slide, or they may scratch the glass.

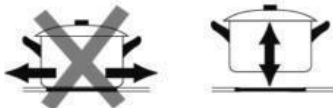

Pan dimensions

The cooking zones are up to a limit, automatically adapted to the diameter of the pan. However the bottom of this pan must have a minimum of diameter according to the corresponding cooking zone. To obtain the best efficiency of your hob, please place the pan in the centre of the cooking zone.

Cooking zone	Minimum (mm)
1. 2 (180 x 180 mm)	120
Flex zone	240 or 160 x 270
3 (210 mm)	140
4 (160 mm)	100
5 (300mm)	180

Use Instruction

To start cooking

1. Touch the ON/OFF control.

After power on, the buzzer beeps once, all displays show “-” or “--”, indicating that the induction hob has entered the state of standby mode.



2. Place a suitable pan on the cooking zone that you wish to use.

- Make sure the bottom of the pan and the surface of the cooking zone are clean and dry.

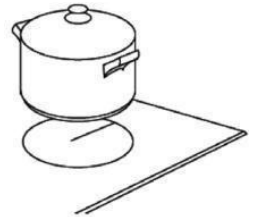

3. Touching the heating zone selection control, and an indicator next to the key will flash.



4. Select a heating zone and set a power level by touching the slider, or the "+" or "-" control, or just touch any point of the "---"

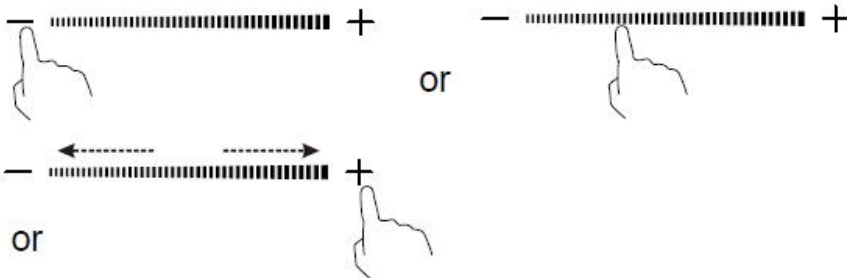

a. If you don't set the power within 1 minute, the induction hob will automatically switch off. You will need to start again at step 1.

b. You can modify the heating setting at anytime during cooking (But pls select the heating zone first which you want to choose)

c. If side along the "---", power will vary from level 1 to level 9.

If the display flashes alternately with the heat setting

This means that:

- you have not placed a pan on the correct cooking zone or,
- the pan you're using is not suitable for induction cooking or,
- the pan is too small or not properly centred on the cooking zone.

No heating takes place unless there is a suitable pan on the cooking zone.

The display will automatically turn off after 1 minutes if no suitable pan is placed on it.

When you have finished cooking

1.Touching the cooking zone that you wish to switch off.

And turn the cooking zone off by touching the "-" or sliding along the "---" to the left side,and then hold for 1 second.

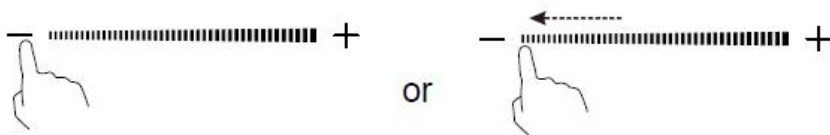

2.Make sure the display shows "0",then show"H".

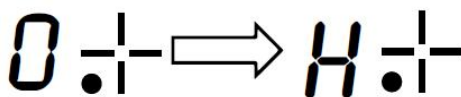

3.Turn the whole cooktop off by touching the ON/OFF control.

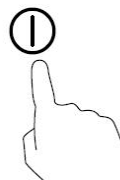

4.Beware of hot surfaces " H " will show which cooking zone is hot to touch. It will disappear when the surface has cooled down to a safe temperature. It can also be used as an energy saving function if you want to heat further pans, use the hotplate that is still hot.

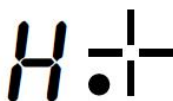

Using the Boost function

Boost is the function that one zone rises to a high power level in one second and lasts for 5 minutes. Then you can get a more powerful and faster cooking.

Using boost to cook at high power

1.Touch the heating zone selection button that you wish to boost, an indicator next to the key will flash.

2.Touch the Boost button, the heating zone will begin to work at Boost mode. The power display will show "P" to indicate that the zone is boosting.

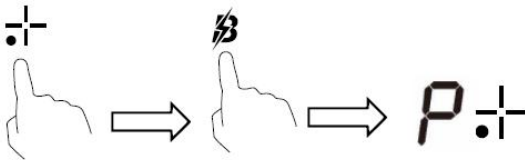

3. The Boost power will last for 5 minutes and then the zone will go back to the power level which was set before boost.



4. If you want to cancel the Boost during this 5 minutes, touch the heating zone selection button (an indicator next to the key will flash), and then touch the Boost button. The heating zone will go back to the power level which was set before boost.

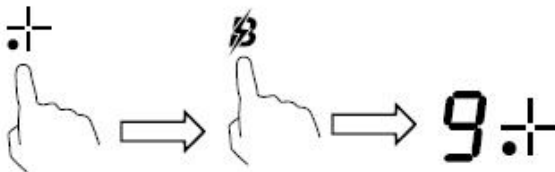

Restrictions for using Boost

The five zone model were divided into two groups, in group a, if use boost on one zone, first make sure that the other zone is working on/below power level 5. Another situation is it can set boost function for both zone in the same group when this group is in flex function mode. In group b, you can only use Boost function for one zone at a time. If you try to use the Boost for two zones at the same time, the first zone which use Boost function will drop out of boost function.

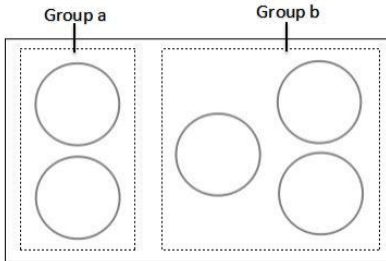

Using the Keep Warm function

The Keep Warm function is suitable for keeping food warm.

1. Touch the heating zone selection button to select a desired cooking zone. An indicator next to the key will flash.



2. Touch the  button, and then hold it for 1 seconds, the cooking zone indicator will display "A", The function has now been activated.

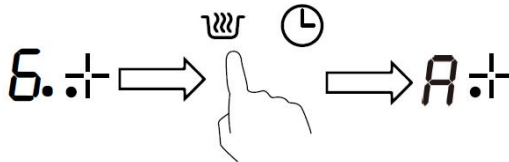

3. If you want to cancel the Keep Warm, selection button, and then hold the button  for 1 seconds. The heating zone will go back to Power level "0".

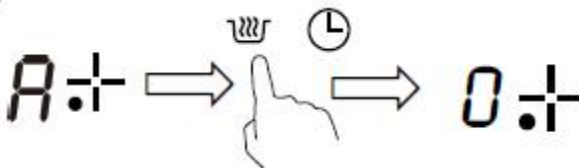

Flexible Area

- This area can be used as a single zone or as two different zones, accordingly to the cooking needs anytime.
- Flexible area is made of two independent inductors that can be controlled separately.
- Important: Make sure to place the cookwares centered on the single cooking zone.

When using a big pot, oval, rectangular and elongated pans, make sure to place the pans centered on the cooking zone covering both cross.

- Good and bad examples of pot placement:

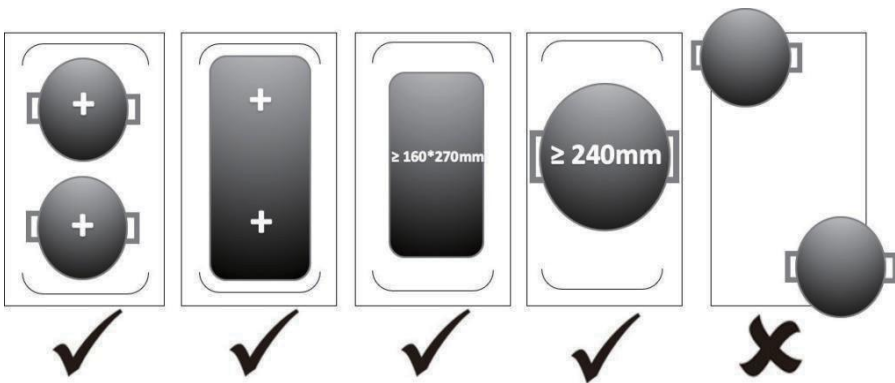

As a single big zone

1. To activate the flexible area as a single big zone, choose the zone that has the flex function and press the flex zone icon as shown on the right image.

2. The power setting works any other normal area.

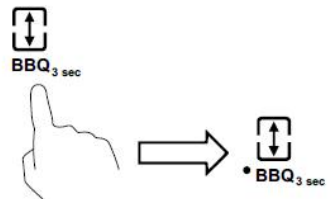

As two independent zones

1.To use the flexible area as two different zones with different power settings, press the flex zone selection button again and the zones will return into their previous settings.

Using the Flex Zone function

1.Touch the zone selection button to active the zone, and then touch the flexzone key and hold for 1 seconds.Then the zones in the flex group will show the same power level,flex zone function active.

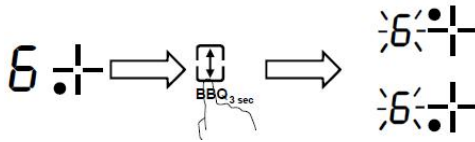

2.To turn off the flex zone,choose one of the zones in the flex group and touch the flex zone selection button,then flex zone function quit.

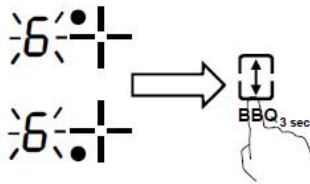

Using the BBQ function

The BBQ function can be used at the flexzone mode which will allow the pan surface temperature staying at a suitable level.

1.Touch the zone selection button to active the zone, and then touch the flexzone key and hold for 3 seconds.The hob will go into the BBQ mode, and will show “b” and “q”.

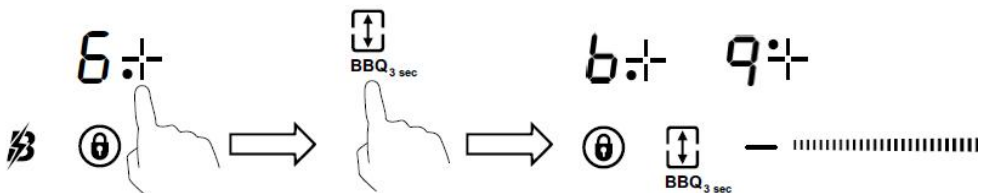

2.If you want to cancel the barbecue function, just touch the zone selection control which you choose and then touch the flex zone control for 3 seconds. Then the cooking zone indicator will display “0”.Now you can reset the power level.

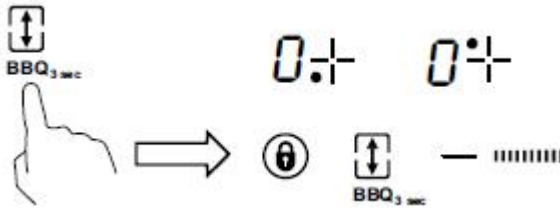

Locking the controls

- You can lock the controls to prevent unintended use (for example children accidentally turning the cooking zones on).
- When the controls are locked, all the controls except the ON/OFF control are disabled.

To lock the controls

Touch the key lock control  the timer indicator will show “Lo”

To unlock the controls

1. Make sure the Induction hob is turned on.
2. Touch and hold the key lock control  for a while.
3. You can now start using your Induction hob.

 When the hob is in the lock mode,all the controls are disable except the ON/OFF , You can always turn the induction hob off with the ON/OFF control in an emergency,but you”ll need to unlock the hob first before you can make any further operations.

Device protections

Over-temperature protection

A temperature sensor equipped can monitor the temperature inside the Induction hob. When an excessive temperature is monitored, the Induction hob will stop operation automatically.

Over-spillage protection

Over-spillage protection is a safety protection function. It switch off the hob automatically within 10s if the water flow to the control panel, while buzzer will beep 1 second.

Detection of small articles

When an unsuitable size or non-magnetic pan (e.g. aluminium), or some other small item (e.g. knife, fork, key) has been left on the hob, the hob automatically go on to standby in 1 minute. The fan will keep cooking down the induction hob for a further 1 minute.

Auto shutdown protection

Auto shut down is a safety protection function for your induction hob. It shut down automatically if ever you forget to turn off your cooking. The default working times for various power levels are shown in the below table:

Power level	1	2	3	4	5	6	7	8	9
Default working timer (hour)	8	8	8	4	4	4	2	2	2

When the pot is removed, the induction hob can stop heating immediately and the hob automatically switch off after 2 minutes.



People with a pacemaker should consult with their doctor before using this unit.

Using the Timer

You can use the timer in two different ways:

- You can use it as a minute minder. In this case, the timer will not turn any cooking zone off when the set time is up.
- You can set it to turn one cooking zone off after the set time is up.
- You can set the timer up to 99 minutes.

Using the Timer as a Minute Minder

1. Make sure the cooktop is turned on.

Note: You can use the minute minder even if you're not selecting any cooking zone

2. Touch timer control, The minder indicator will start flashing and "30" will show in the time display.

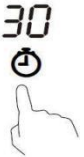

3. Set the time by touching the slider control.

Hint: Touch the two sides of timer control once to decrease or increase by 1 Minute.

Hold the "-" or "+" control of the timer to decrease or increase by 10 minutes.

If the setting time exceeds 99 minutes, the timer will automatically return to 0.

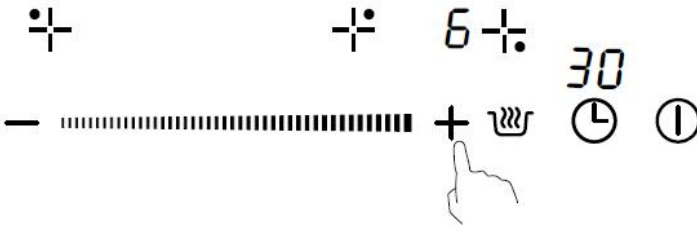

4. When the time is set, it will begin to count down immediately. The display will show the remaining time and the timer indicator will flash for 5 seconds.



5. Buzzer will beep for 1 second and the timer indicator shows "--" when the setting time expires.

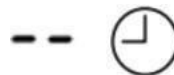

Setting the timer to turn one cooking zone off

1. Touching the heating zone selection control that you want to set the timer off.

2. Touch timer control, The minder indicator will start flashing and "30" will show in the timer display.

3. Set the time by touching the "+" or "-" control.

Hint: Touch the "-" or "+" control of the timer once will decrease or increase by 1 minute.

Hold the "-" or "+" control of the timer once will decrease or increase by 10 minutes

If the setting time exceeds 99 minutes, the timer will automatically return to 0.

4. When the time is set, it will begin to count down immediately. The display will show the remaining time and the timer indicator flash for 5 seconds.

NOTE: The red dot next to power level indicator will illuminate indicating that zone is selected.

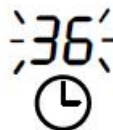
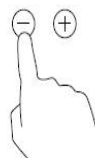
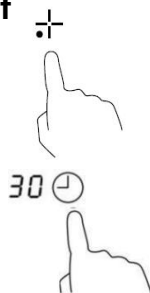

5. To cancel the timer, touch the heating zone selection control, and then touch the timer control. Then the minute display will show "00" and then "--", the timer is cancelled.

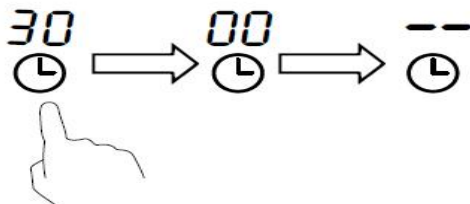

6. When cooking timer expires, the corresponding cooking zone will be switch offautomatically and will show “H”

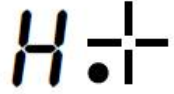

Other cooking zone will keep operating if they are turned on previously.

Setting the timer to turn more than one cooking zone off

If you use this function on more than one heating zones, the timer indicator will show the shortest time.

(e.g. zone #1 setting time of 2 minutes and zone #2 setting time of 5 minutes, the timer indicator shows “2”.)

NOTE: The flashing red dot next to power level indicator means the timer indicator is showing time of the heating zone.

If you want to check the set time of other heating zones, touch the heating zone slide control once,The timer will indicate its set time.



(set to 6 minutes)

(set to 3 minutes)

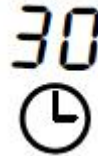

2. When cooking timer expires,the corresponding heating zone will be automatically switched off and show “H”



NOTE:If you want to change the time after the timer is set,you have to shart from step1.

Cooking Guidelines



Take care when frying as the oil and fat heat up very quickly. At extremely high temperatures oil and fat will ignite spontaneously and this presents a serious fire risk.

Cooking Tips

- When food comes to the boil, reduce the temperature setting.
- Using a lid will reduce cooking times and save energy by retaining the heat.
- Minimise the amount of liquid or fat to reduce cooking times.
- Start cooking on a high setting and reduce the setting when the food has heated through.

Simmering, cooking rice

- Simmering occurs below boiling point, at around 85°C, when bubbles are just rising occasionally to the surface of the cooking liquid. It is the key to delicious soups and tender stews because the flavours develop without overcooking the food. You should also cook egg-based and flour thickened sauces below boiling point.
- Some tasks, including cooking rice by the absorption method, may require a setting higher than the lowest setting to ensure the food is cooked properly in the timer commended.

Searing steak

To cook juicy flavour some steaks:

1. Stand the meat at room temperature for about 20 minutes before cooking.
2. Heat up a heavy-based frying pan.
3. Brush both sides of the steak with oil. Drizzle a small amount of oil into the hot pan and then lower the meat onto the hot pan.
4. Turn the steak only once during cooking. The exact cooking time will depend on the thickness of the steak and how cooked you want it. Times may vary from about 2 – 8 minutes per side. Press the steak to gauge how cooked it is – the firmer it feels the more 'well done' it will be.
5. Leave the steak to rest on a warm plate for a few minutes to allow it to relax and become tender before serving.

For stir-frying

1. Choose an induction compatible flat-based wok or a large frying pan.
2. Have all the ingredients and equipment ready. Stir-frying should be quick. If cooking large quantities, cook the food in several smaller batches.

3. Preheat the pan briefly and add two tablespoons of oil.
4. Cook any meat first, put it aside and keep warm.
5. Stir-fry the vegetables. When they are hot but still crisp, turn the cooking zone to a lower setting, return the meat to the pan and add your sauce.
6. Stir the ingredients gently to make sure they are heated through.
7. Serve immediately.

Heat Settings

The settings below are guidelines only. The exact setting will depend on several factors, including your cookware and the amount you are cooking. Experiment with the induction hob to find the settings that best suit you.

Heat setting	Suitability
1 - 2	<ul style="list-style-type: none">• delicate warming for small amounts of food• melting chocolate, butter, and foods that burn quickly• gentle simmering• slow warming
3 - 4	<ul style="list-style-type: none">• reheating• rapid simmering• cooking rice
5 - 6	<ul style="list-style-type: none">• pancakes
7 - 8	<ul style="list-style-type: none">• sauteing• cooking pasta
9	<ul style="list-style-type: none">• stir-frying• searing• bringing soup to the boil• boiling water

Care and Cleaning

What?	How?	Important!
<p>Everyday soiling on glass (fingerprints, marks, stains left by food or non-sugary spillovers on the glass)</p>	<ol style="list-style-type: none"> 1. Switch the power to the cooktop off. 2. Apply a cooktop cleaner while the glass is still warm (but not hot!) 3. Rinse and wipe dry with a clean cloth or paper towel. 4. Switch the power to the cooktop back on. 	<ul style="list-style-type: none"> • When the power to the cooktop is switched off, there will be no 'hot surface' indication but the cooking zone may still be hot! Take extreme care. • Heavy-duty scourers, some nylon scourers and harsh/abrasive cleaning agents may scratch the glass. Always read the label to check if your cleaner or scourer is suitable. • Never leave cleaning residue on the cooktop: the glass may
<p>Boilovers, melts, and hot sugary spills on the glass</p>	<p>Remove these immediately with a fish slice, palette knife or razor blade scraper suitable for Induction glass cooktops, but beware of hot cooking zone surfaces:</p> <ol style="list-style-type: none"> 1. Switch the power to the cooktop off at the wall. 2. Hold the blade or utensil at a 30° angle and scrape the soiling or spill to a cool area of the cooktop. 3. Clean the soiling or spillup with a dish cloth or paper towel. 4. Follow steps 2 to 4 for 'Everyday soiling on glass' above. 	<ul style="list-style-type: none"> • Remove stains left by melts and sugary food or spillovers as soon as possible. If left to cool on the glass, they may be difficult to remove or even permanently damage the glass surface. • Cut hazard: when the safetycover is retracted, the blade in a scraper is razor-sharp. Use with extreme care and always store safely and out of reach of children.
<p>Spillovers on the touch controls</p>	<ol style="list-style-type: none"> 1. Switch the power to the cooktop off. 2. Soak up the spill 3. Wipe the touch control area with a clean damp sponge or cloth. 4. Wipe the area completely dry with a paper towel. 5. Switch the power to the cooktop back on. 	<ul style="list-style-type: none"> • The cooktop may beep and turn itself off, and the touch controls may not function while there is liquid on them. Make sure you wipe the touch control area dry before turning the cooktop back on.

Hints and Tips

Problem	Possible causes	What to do
The induction hob cannot be turned on.	No power.	Make sure the induction hob is connected to the power supply and that it is switched on. Check whether there is a power outage in your home or area. If you've checked everything and the problem persists, call a qualified technician.
The touch controls are unresponsive.	The controls are locked.	Unlock the controls. See section 'Using your induction cooktop' for instructions.
The touch controls are difficult to operate.	There may be a slight film of water over the controls or you may be using the tip of your finger when touching the controls.	Make sure the touch control area is dry and use the ball of your finger when touching the controls.
The glass is being scratched.	Rough-edged cookware. Unsuitable, abrasive scourer or cleaning products being used.	Use cookware with flat and smooth bases. See 'Choosing the right cookware'. See 'Care and cleaning'.
Some pans make crackling or clicking noises.	This may be caused by the construction of your cookware (layers of different metals vibrating differently).	This is normal for cookware and does not indicate a fault.
The induction hob makes a low humming noise when used on a high heat setting.	This is caused by the technology of induction cooking.	This is normal, but the noise should quieten down or disappear completely when you decrease the heat setting.

<p>Fan noise coming from the induction hob.</p>	<p>A cooling fan built into your induction hob has come on to prevent the electronics from overheating. It may continue to run even after you've turned the induction hob off.</p>	<p>This is normal and needs no action. Do not switch the power to the induction hob off at the wall while the fan is running.</p>
<p>Pans do not become hot and appears in the display.</p>	<p>The induction hob cannot detect the pan because it is not suitable for induction cooking.</p> <p>The induction hob cannot detect the pan because it is too small for the cooking zone or not properly centred on it.</p>	<p>Use cookware suitable for induction cooking. See section 'Choosing the right cookware'.</p> <p>Centre the pan and make sure that its base matches the size of the cooking zone.</p>
<p>The induction hob or cooking zone has turned itself off unexpectedly, a tone sounds and an error code is displayed (typically alternating with one or two digits in the cooking timer display)</p>	<p>Technical fault</p>	<p>Please note down the error letters and numbers, switch the power to the induction hob off at the wall, and contact a qualified technician.</p>

Troubleshooting

If an abnormality comes up, the induction hob will enter the protective state automatically and display corresponding protective codes:

Problem	Possible causes	What to do
F3/F4	Temperature sensor of the induction coil failure	Please contact the supplier.
F9/FA	Temperature sensor of the IGBT failure.	Please contact the supplier.
E1/E2	Abnormal supply voltage	Please inspect whether power supply is normal. Power on after the power supply is normal.
E3	High temperature of the induction coil temperature sensor	Please contact the supplier.
E5	High temperature of the IGBT temperature sensor	Please restart after the hob cools down.

The above are the judgment and inspection of common failures.

Please do not disassemble the unit by yourself to avoid any dangers and damages to the induction hob.

Installation instruction

Selection of installation equipment

Cut out the work surface according to the sizes shown in the drawing. For the purpose of installation and use, a minimum of 5 cm space shall be preserved around the hole. Be sure the thickness of the work surface is at least 30mm. Please select heat-resistant work surface material to avoid larger deformation caused by the heat radiation from the hotplate. As shown below:

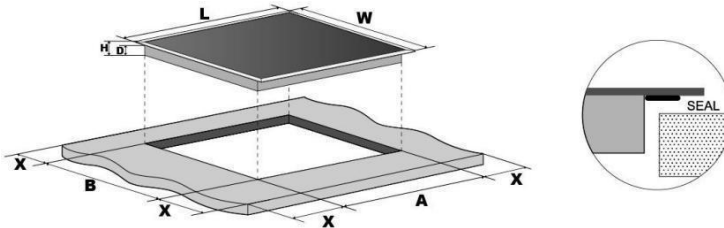

L(mm)	W(mm)	H(mm)	D(mm)	A(mm)	B(mm)	X(mm)
900	520	60	56	870	490	50 mini

Under any circumstances, make sure the Induction cooker hob is well ventilated and the air inlet and outlet are not blocked. Ensure the Induction cooker hob is in good work state. As shown below



Note: The safety distance between the hotplate and the cupboard above the hotplate should be at least 760mm.

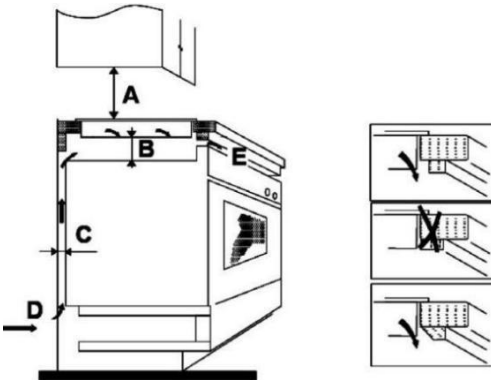

A(mm)	B(mm)	C(mm)	D	E
760	50 mini	20 mini	Air intake	Air exit 5mm

Adjusting the bracket position

Fix the hob on the work surface by screw 4 brackets on the bottom case of hob (see picture) after installation.

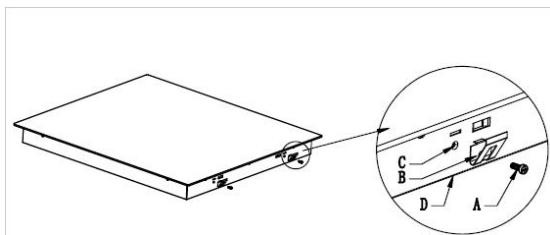

A	B	C	D
Screw	Bracket	Screw hole	Bottom case

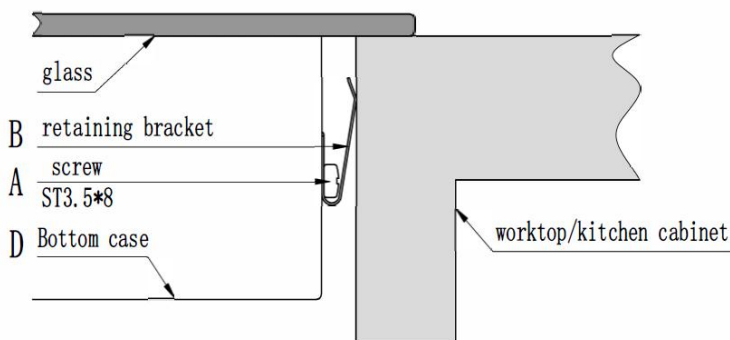

Cautions

1. The induction hotplate must be installed by qualified personnel or technicians. We have professionals at your service. Please never conduct the operation by yourself.
2. The hob will not be installed directly above a dishwasher, fridge, freezer, washing machine or clothes dryer, as the humidity may damage the hob electronics.
3. The induction hotplate shall be installed such that better heat radiation can be ensured to enhance its reliability.
4. The wall and induced heating zone above the table surface shall with stand heat.
5. To avoid any damage, the sandwich layer and adhesive must be resistant to heat.

To connect the hob to the mains power supply, do not use adapters, reducers, or branching devices, as they can cause overheating and fire. The power supply cable must not touch any hot parts and must be positioned, so that its temperature will not exceed 75°C at any point

Connecting the hob to the mains power supply

This hob must be connected to the mains power supply only by a suitably qualified person. Before connecting the hob to the mains power supply, that:



1. the domestic wiring system is suitable for the power drawn by the hob.
2. the voltage corresponds to the value given in the rating plate
3. the domestic wiring system is suitable for the power drawn by the hob.
4. the voltage corresponds to the value given in the rating plate
5. the power supply cable sections can withstand the load specified on the rating plate.

The power supply should be connected in compliance with the relevant standard, or a single-pole circuit breaker, the method of connection is shown below.

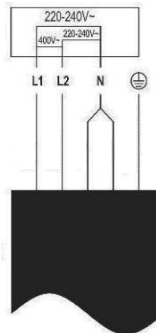
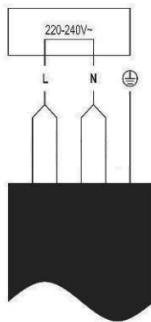

- If the cable is damaged or to be replaced, the operation must be carried out the by after-sale agent with dedicated tools to avoid any accidents.
- If the appliance is being connected directly to the mains an omnipolar circuit-breaker must be installed with a minimum opening of 3mm between contacts.
- The installer must ensure that the correct electrical connection has been made and that it is compliant with safety regulations.
- The cable must not be bent or compressed.
- The cable must be checked regularly and replaced by authorised technicians only.

Disposal



This appliance is labelled in accordance with European Directive 2012/19/EU regarding electric and electronic appliances (WEEE). The WEEE contain both polluting substances (that can have a negative effect on the environment) and base elements (that can be reused). It is important that the WEEE undergo specific treatments to correctly remove and dispose of the pollutants and recover all the materials. Individuals can play an important role in ensuring that the WEEE do not become an environmental problem; It is essential to follow a few basic rules:

- the WEEE should not be treated as domestic waste;
- the WEEE should be taken to dedicated collection areas managed by the town council or a registered company.

In many countries, domestic collections may be available for large WEEE. When you buy a new appliance, the old one can be returned to the vendor who must accept it free of charge as a one-off, as long as the appliance is of an equivalent type and has the same functions as the purchased appliance.

Edition:A/0

Publication Date:December. 05.2022

ROBAM